

Lounge Seating price book

Prices effective July 5, 2023

Published July 5, 2023

General Information	2
How to Specify	4
Base Finishes	5-6
Fire Retardancy	7
Upholstery	8-10
Upholstery COM/COL Procedures	11
Upholstery Upcharges	12-17
Upholstery Application Chart	18-25
Wood Finishes	26-27

Brabo™	Vincent Van Duysen	24
Bumper™	Ward Bennett	27
Clamshell™	BassamFellows	28
Crosshatch™	EOOS	29
Crosshatch Outdoor	EOOS	30
Full Loop	EOOS	32
Mantle	BassamFellows	35
Rapport™	Isay Weinfield	41
Reframe™	EOOS	47
Rolled Arm™	Ward Bennett	48
Saiba™	Naoto Fukasawa	49
Scissor™	Ward Bennett	51
Sled™	Ward Bennett	56
Tuxedo Component Lounge™	BassamFellows	53
Tuxedo Classic Lounge™	BassamFellows	70
Tuxedo Classic Connecting Lounge™	BassamFellows	73
U-Series™	Ward Bennett	87

Application of Standard Terms

Only the standard terms of sale stated in this catalog apply to any transaction unless those terms are modified or supplemented by a written document signed by an officer of Geiger International, Inc. ("Geiger"). Any terms contained in Customer's purchase order, including standard printed provisions, that are additional to or contrary to these terms, are not effective.

Use of Furniture and Materials

Geiger assumes that textiles, leathers and products are intended for commercial use and are not being bought for use primarily for personal, family, or household purposes. When installed and used as intended, products remain chattel property, are not considered fixtures, and no interest in them should arise under applicable real estate law.

Furniture Prices

Prices are determined by using the published list prices in effect when Geiger receives Customer's completed purchase order. If Customer's requested ship date is more than three months after Geiger receives Customer's order, it may be repriced using the list prices in effect when products ship. If Customer designates special finishes or options, additional charges may apply. Services such as design, project management, packaging, storage, inside delivery, double handling, installation, or inventory management are not included in Geiger's list prices.

COM / COL Procedures

If an order includes Customer-supplied materials, Customer must ship those materials to Geiger at Customer's own expense. The materials must be tagged with Geiger's confirmation number, item number, Customer's name, and purchase order number. Geiger is not liable for inadequacies in Customer's materials. Geiger will notify Customer of any apparent defects in Customer's materials before manufacturing.

Taxes

Customer is responsible for any local sales taxes or other similar taxes imposed on transactions.

Delays

Geiger is not liable for failure to ship by the acknowledged shipping date or any other date. Geiger is not liable for a delay or failure in shipment or performance if the delay or failure is caused by acts of omission of Customer, its agents, employees, contractors, a governmental authority, or God; delays in transportation; or other similar causes that are not within Geiger's reasonable control. Geiger is excused from further performance of its obligations for the duration of a force majeure cause.

Changes and Cancellation

Geiger's acceptance of an order is final and binding and an order may not be changed or canceled without Geiger's written consent.

Orders placed on any of Geiger's expedited shipment programs and orders of custom-dyed or custom-woven materials may not be changed or canceled. To change or cancel other orders, contact Geiger Customer Care in writing for authorization and applicable charges.

Storage

If Customer cannot accept delivery when products are ready, it is the customer's responsibility to transfer products to storage and products are invoiced at that time. Customer is responsible for actual storage charges and any other expenses relating to the storage of products or materials. Customer bears all risk of loss for products or materials in storage.

Freight Terms

For casegoods and seating orders shipped within the 48 contiguous United States, surface freight charges are included. For textile and leather orders actual freight charges will be invoiced. Orders are shipped via ground carrier unless requested otherwise.

For orders shipped to Alaska or Hawaii, the freight terms stated above apply only to the port of embarkation. Shipments beyond that point are freight collect. Domestic deliveries are shipped FOB Geiger's plant to a destination designated by Customer by a method Geiger selects.

All textile shipments will be made FOB Geiger Textiles, Yaphank, NY 11980. All leather shipments will be made FOB Geiger Textiles, Hildebran, NC 28637.

Packaging and Shipping

Geiger's casegoods products are shipped in component form. Shipments over \$50,000 net are blanket wrapped. Tops and panels are shrink wrapped with cardboard corner protection. Pedestals, storage units, overheads and vertical storage units are wrapped in blankets and shrink wrapped with cardboard corner protection. Blankets are to be returned to Geiger for reuse. If the customer request cartoning on orders over \$50,000 net, there will be a charge of five percent of the net order. Packing materials are recyclable.

Shipments from Geiger Atlanta under \$50,000 net are cartoned. Cartoned shipments are packaged with cardboard channels and shrink wrap.

Geiger seating is cartoned in boxes for all shipments. Blanket wrapping is available upon request.

If Customer requests special shipping or delivery methods, Customer is responsible for any extra costs that result.

Packaging and Shipping (continued)

Customer obtains title to products and materials and assumes the risk of loss for them upon shipment from Geiger's plant. Geiger reserves the right to make partial shipments, of truckload quantities, as products are manufactured.

Shipping Surcharge

A shipping surcharge will be added to all orders under \$100,000 list based on the ship-to address. The surcharge is a percentage of the total list price of the entire order, calculated on the base price only. Upcharges for veneer, edges, textiles, pulls, etc., are not counted in the calculation.

Zone 1	3.6%	(GA, NC, SC)
Zone 2	4.2%	(AL, FL, MS, TN, AR, LA)
Zone 3	4.8%	(IL, IN, KY, MI, OH, WI, IA, KS, MN, MO, ND, NE, SD, DC, MD, VA)
Zone 4	5.4%	(CT, MA, ME, NH, RI, VT, DE, NJ, NY, PA, WV)
Zone 5	6.0%	(OK, TX, AZ, NM, NV, UT, CO)
Zone 6	6.6%	(OR, WA, ID, MT WY, CA, Canada)

International Shipping

Orders for export are shipped Ex Works factory (Incoterms 2000). The charge for export packing is five percent of the net order value. There are no export packing charges on shipments to Canada.

Claims

All blanket wrapped shipments must be unwrapped and inspected at the dock, in the presence of the driver. Claims for "concealed damage" or "subject to inspection" will not be honored on blanket wrapped shipments. All cartoned shipments must be inspected for visual outside damage to the package.

Damages and piece count shortages must be noted on the bill of lading. Freight claims must be filed within 30 days (including cartoned shipments with concealed damage). Contact Customer Care for a warranty/freight claim form and send it by fax, mail or email to:

Geiger International
6095 Fulton Industrial Blvd., SW
Atlanta, GA 30336-2806
Attention: Warranty Department
Fax: 1.404.836.7519

Order Information

Herman Miller dealers must submit all purchase orders to Geiger via Omni. For assistance with this process, please contact Herman Miller Sales Technology Support at 800.833.3330.

All Geiger Gallery and non-Herman Miller dealers may submit their orders via email or fax at 404.836.7519. For assistance with this

Order Information (continued)

process, please contact Geiger Customer Care at 800.456.6452.

Midwest	custcaremw@geigerfurniture.com
New York	custcareny@geigerfurniture.com
Northeast	custcarene@geigerfurniture.com
South	custcaresouth@geigerfurniture.com
West	custcarewest@geigerfurniture.com
Int'l	custcareintl@geigerfurniture.com

Warranty

Geiger International, Inc. ("Geiger"), 6095 Fulton Industrial Blvd., SW, Atlanta, GA 30336-2806, USA, warrants the products sold by it to be free from defects in material and workmanship, regardless of the number of shifts during which the products are used, for the warranty periods specified below.

This warranty covers the sale of Geiger product in all countries. Not all of the product lines appearing on this list are marketed by Geiger in all countries, and appearance on this list does not imply an offer for sale of a product line in a particular place. Product line availability is defined in current price lists applicable to different regions.

Geiger Commercial Office Furniture Products 12 years

All products sold under the Geiger® brand name, except as limited or described below.

Textiles and Leathers 3 years

Includes, but is not limited to Edelman Leather, Geiger, Herman Miller, Maharam, and Place fabrics.

Nonstandard Products 1 to 5 years

Warranty length on nonstandard products not covered by the 12-year warranty is identified on individual product quotes.

All Other Products, Parts, and Services 2 years

Height adjustable bases (electrical parts)

5 years

Height adjustable bases (mechanical parts)
Task light electronic ballasts

3 years

All service parts

6 months

All other products, parts, and any services not listed above, sold or furnished by Geiger, except for consumable products such as light bulbs and other electronic products for which no warranty is given

Warranty (continued)

Other Manufacturers' Products

None

Geiger will pass through to the original purchaser any warranty supplied by other manufacturers to the extent possible, including, but not limited to, open-line laminates.

Provisions that apply to all products and services:

During the applicable warranty period, Geiger, as its sole obligation, will repair or replace (at its option) any product, part, or component covered by this warranty and sold after the effective date of this warranty, which fails under normal use as a result of a defect in material or workmanship; Geiger will repair or replace the aforementioned product, part, or component with a comparable product, part, or component.

This warranty extends only to the original purchasers who acquire new product from Geiger, or its authorized resellers. Any product, part, or component must have been installed, used, and maintained according to Geiger's published instructions in order to be eligible for coverage under this warranty and must not have been subject to misuse or abuse. Any modification to the original product voids the warranty. Geiger does not warrant the performance of the product when used in combination with other than original Geiger product.

The warranty period starts from the date of purchase.

This document inclusively describes all of the warranties given and remedies available with respect to the company's products and services. Geiger disclaims any other warranty whether express or implied, statutory or otherwise, in relation to the products.

Geiger does not warrant:

- natural variations in wood grain or figure or the presence of character marks
- changes in surface finishes due to aging or exposure to light
- marks, scars, or wrinkles occurring naturally in leather
- veins, marks, voids, fissures, or cracks found naturally in stone

In addition, Geiger does not warrant:

- failure resulting from normal wear and tear
- the matching of colors, grains, or textures of natural materials
- the colorfastness or the matching of colors of textiles, including an exact match to cuttings or to swatch cards
- damage, marking, or staining of veneer surfaces due to contact with rubber or similar compounds; damage from sharp objects or imprinting from writing instruments, or prolonged exposure to direct sunlight

Warranty (continued)

Geiger tests Customer's Own Material (COM) and other customer-supplied items for manufacturing quality only and does not provide any warranty with regard to these materials.

Geiger does not warrant products that are exposed to extreme environmental conditions or that have been subject to improper storage.

Geiger's products meet the requirements of national and specific local codes as stated in the price books and other written publications.

TO THE EXTENT ALLOWED BY LAW, ANY IMPLIED WARRANTIES, INCLUDING ANY WARRANTY OF MERCHANTABILITY OR FITNESS FOR A PARTICULAR PURPOSE, ARE DISCLAIMED AND TO THE EXTENT THEY ARE LEGALLY REQUIRED, ARE LIMITED IN DURATION TO THE DURATION OF THIS WRITTEN WARRANTY.

GEIGER SHALL NOT BE LIABLE FOR LOSS OF TIME, INCONVENIENCE, COMMERCIAL LOSS, OR INCIDENTAL OR CONSEQUENTIAL DAMAGES.

Applies in US only: Some states do not allow limitations on how long an implied warranty lasts or do not allow the exclusion or limitation of incidental or consequential damages, so the limitations or exclusions in the two preceding paragraphs may not apply. This warranty gives the purchaser specific legal rights; however, the purchaser may also have other rights that may vary from state to state.

Applies outside US: Except as stated above, Geiger will not be liable for any loss or damage (including costs) however caused, whether direct or consequential, incurred or suffered by the purchaser or any third party in respect of the products but nothing contained herein will or will be considered to exclude or restrict any liability on Geiger's part for death or personal injury resulting from negligence.

Limitations and Disclaimers

Geiger is not liable for loss of time, inconvenience, lost profits, commercial loss, or other special, consequential, or incidental damages for any transaction.

Geiger reserves the right to change its designs, its methods of construction, or its prices, charges, or policies at any time without notice to Customer.

Design Rights

The designs depicted in Geiger's catalogs and price lists are proprietary to Geiger and Geiger reserves the exclusive right to manufacture them. Any reproduction of these designs infringes Geiger's rights and that infringement will be prosecuted.

How to Specify

- For each product ordered, specify a product number string. The string should include the product number and all finish and detail codes in the same sequence as shown at the bottom of the pricebook page.
- Product Number String Example:
SVV4A 943 3A09 998 NOCAL

The product number string above includes all codes for an Brabo lounge chair with the following specifications:

Product Number SVV4A
Seating Wood Finish .. 943 Caramel Cherry
Upholstery 3A/09 Moire/Zin
Base 998 Ebony Ash
Fire Retardancy NOCAL

- Basic Price reflects the price of the seating without upholstery fabric. For total product pricing, determine the price group of the upholstery specified. Add the appropriate upholstery price to the Basic Price. Add additional upcharges for options if required.

Base Finishes

Standard Base Finishes

*For Brabo
(no upcharge)*

BNZBronze
CHR.....Chrome
SACSatin Chrome

Standard Base Metal Finishes

*For Saiba
(no upcharge)*

BK.....Black
CDPolished Aluminum

Standard Base Finishes

*For Scissor
(no upcharge)*

CHR.....Chrome
SACSatin Chrome

Standard Base Metal Finishes

*For Sled
(no upcharge)*

BNZBronze
CHR.....Chrome
SACSatin Chrome

Base Finishes

Standard Base Finishes

For Tuxedo Component Seating
(no upcharge)

926.....Black
AS.....Arctic Silver
PBZ.....Powder Coat Bronze
WHT.....White

Upcharge Base Finishes

For Tuxedo Component Club Chair and
Ottoman without table
(add \$307 upcharge)

BNZ.....Bronze
CHR.....Chrome
SAC.....Satin Chrome

For Tuxedo Component Bench, Daybed, Settee,
and Sofa without table
(add \$671 upcharge)

BNZ.....Bronze
CHR.....Chrome
SAC.....Satin Chrome

For Tuxedo Component Seating with table
(add \$671 upcharge)

BNZ.....Bronze
CHR.....Chrome
SAC.....Satin Chrome

Standard Base Finishes

For Rapport, Tuxedo Classic
(no upcharge)

Code	Description	Wood Base on Ash	Wood Base on Walnut	Rapport and Tuxedo Classic
662	Toasted Walnut, matte	•	•	W
663	Charred Walnut, matte	•	•	W
664	Bronzed Walnut, matte	•	•	W
665	Smoked Walnut, matte	•	•	W
666	Coffee Walnut, matte	•	•	W
667	Smoked Paldao, matte	•	•	W
669	Warm Paldao, matte	•	•	W
677	Chocolate Ash, matte	•		A
66A	RecoGrain Frosty Ash, matte	•		A
66G	RecoGrain Wenge, matte	•	•	W
68R	RecoGrain Rosewood, matte	•	•	W
69A	RecoGrain Frosty Ash, matte	•		A
69R	RecoGrain Rosewood, matte	•	•	W
69T	RecoGrain Teak, matte	•		A
6A1	White Ash, matte	•		A
6ET	Clear On Ash, Ash Solid, matte	•		A
6EU	Oak On Ash, Oak Solid, matte	•		A
6EV	Walnut On Ash, Walnut Solid, matte	•	•	W
6K1	Rift Oak, matte	•		A
6K6	Burnt Oak, matte	•		A
940	Sundance Cherry on Maple, low sheen	•		A
943	Caramel Cherry, low sheen	•		A
946	Cocoa Cherry, low sheen	•		A
956	Cocoa Sapele, low sheen	•		A
962	Toasted Walnut, low sheen	•	•	W
963	Charred Walnut, low sheen	•	•	W
964	Bronzed Walnut, low sheen	•	•	W
965	Smoked Walnut, low sheen	•	•	W
966	Coffee Walnut, low sheen	•	•	W
967	Smoked Paldao, low sheen	•	•	W
969	Warm Paldao, low sheen	•	•	W
972	Sundance Walnut, low sheen		•	W
977	Chocolate Ash, low sheen	•		A
991	Champagne Ash, low sheen	•		A
998	Ebony Ash, low sheen	•		A
96A	RecoGrain Frosty Ash, low sheen	•		A
96G	RecoGrain Wenge, low sheen	•	•	W
98R	RecoGrain Rosewood, low sheen	•	•	W
99R	RecoGrain Rosewood, low sheen	•	•	W
99T	RecoGrain Teak, low sheen	•		A
9A1	White Ash, low sheen	•		A
9K1	Rift Oak, low sheen	•		A
9K6	Burnt Oak, low sheen	•		A
ED	Aged Cherry, low sheen	•		A
EK	Medium Red Walnut, low sheen	•	•	W
ET	RecoGrain Natural Ash, matte	•		A
EU	RecoGrain Oak, matte	•		A
EV	RecoGrain Walnut, matte	•	•	W
G2U	Light Brown Walnut, low sheen	•	•	W
G40	Dark Brown Walnut, low sheen	•	•	W
GOU	Walnut, matte	•	•	W
UX	Walnut On Cherry, low sheen	•		A

Cord

Standard Cords

*For Crosshatch Seating
(no upcharge)*

CBKBlack
CBRDark Brown
CGYGray
CCMCream

Fire Retardancy

NOCALFire retardancy not required

Upholstery • COM/COL

Seating COM/COL Procedures

Geiger accepts COM and COL for application on its products. However, Geiger does not warrant the application, suitability, or performance of those materials. Geiger reserves the right to reject any COM or COL that it considers unsuitable. Geiger will notify Customer of any apparent defects in Customer's materials before manufacture.

Use Basic Price for seating upholstered in Customer's Own Material (COM). Add COL price to Basic Price for seating upholstered in Customer's Own Leather (COL).

Express seating orders that include COM or COL are scheduled at Express leadtime when Geiger receives all the materials on the order. Geiger will split ship COM/COL orders only if Customer notifies Geiger in writing that this is required.

Questions regarding COM procedures should be directed to Geiger Customer Care at 800.456.6452 or Herman Miller COM Department at 616.654.3400.

Testing and Approval

All Customer's Own Material and Customer's Own Leather requires testing and approval prior to order submission. Failure to obtain approval will result in delayed processing and scheduling of the order.

Step 1. Herman Miller dealers should request a COM test number through Omni. Customers and dealers without Omni access should contact Geiger Customer Care at 800.456.6452 for a test number.

Step 2. Send one memo-sized sample tagged with the test number to the below address. Saiba lounge seating requires additional fabric for testing in addition to memo-sized sample. See product page for details.

Geiger North Carolina
218 Cline Park Drive
Hildebran, NC 28637
Attn: COM

Step 3. Within four business days of receipt of the samples you will be contacted by Geiger Customer Care or the Herman Miller COM Department with testing results. If approved, you will be given a four-digit COM number for the fabric, and yardage requirements will be confirmed.

The COM number is specific to each fabric and indicates the supplier name, fabric style name, color and applied direction of the fabric. It must be shown on the purchase order and on the COM and COL tagging when shipped to Geiger.

Tagging and Shipment

If an order is to include materials supplied by the Customer, Customer must ship materials to Geiger at Customer's own expense. In order to match the appropriate material with the Customer's order, all COM and COL must be tagged as follows:

COM/COL No. _____
Dealer Name _____
Customer Name _____
Dealer P.O. No. _____
Geiger Order No. _____
Product Item No. _____

For all seating:

Geiger North Carolina
218 Cline Park Drive
Hildebran, NC 28637
Attn: COM

Geiger is not responsible for delays caused by fabric not correctly marked or shipped to the wrong location. Freight charges to ship COM from an incorrect location to Geiger may be charged to the Customer.

COM/COL Requirements

Yardages listed for COM are based on 54" wide fabric, with no repeat. Fabrics which have a repeat that must be matched, or are less than 54" wide, require more yardage and the following chart should be used for determining COM yardage requirements. For fabric with both horizontal and vertical repeats, add the horizontal and vertical repeat inches together. Use the total number of repeat inches to determine the additional fabric needed.

Fabric Width	Plain Fabric	2"- 10" Repeat	11"- 20" Repeat	21"- 25" Repeat	26"- 30" Repeat
54"	0%	10%	15%	20%	25%
51" - 53"	15%	20%	25%	30%	35%
48" - 50"	30%	35%	40%	45%	50%
45" - 47"	45%	50%	55%	60%	65%
36" - 44"	60%	65%	70%	75%	80%

COL requirements are shown in square feet and figured on hides that are 55 square feet or larger. On smaller hides, add 15% to the COL requirements. Hides other than cowhide leather cannot be accepted.

Upholstery Upcharges											
	Yardage Requirement										
Yardage	1/4	1/2	3/4	1	1 1/4	1 1/2	1 3/4	2	2 1/4	2 1/2	2 3/4
Sq. Feet	4 1/2	9	13 1/2	18	22 1/2	27	31 1/2	36	40 1/2	45	49 1/2
COL	+23	+45	+68	+90	+113	+135	+158	+180	+203	+225	+248
Group 1	+12	+25	+37	+49	+61	+74	+86	+98	+110	+123	+135
Group 2	+15	+30	+44	+59	+74	+89	+103	+118	+133	+148	+162
Group 3	+18	+37	+55	+73	+91	+110	+128	+146	+164	+183	+201
Group 4	+23	+45	+68	+90	+113	+135	+158	+180	+203	+225	+248
Group 5	+33	+66	+98	+131	+164	+197	+229	+262	+295	+328	+360
Group 6	+43	+87	+130	+173	+216	+260	+303	+346	+389	+433	+476
Group 7	+53	+106	+159	+212	+265	+318	+371	+424	+477	+530	+583
Group 8	+81	+162	+243	+324	+405	+486	+567	+648	+729	+810	+891
Group 9	+101	+201	+302	+402	+503	+603	+704	+804	+905	+1005	+1106
Group 10	+116	+232	+347	+463	+579	+695	+810	+926	+1042	+1158	+1273
Group 11	+130	+259	+389	+518	+648	+777	+907	+1036	+1166	+1295	+1425
Group 12	+148	+296	+444	+592	+740	+888	+1036	+1184	+1332	+1480	+1628
Group 13	+153	+306	+459	+612	+765	+918	+1071	+1224	+1377	+1530	+1683
Group 14	+170	+340	+509	+679	+849	+1019	+1188	+1358	+1528	+1698	+1867
Group A	+10	+21	+31	+41	+51	+62	+72	+82	+92	+103	+113
Group B	+12	+24	+35	+47	+59	+71	+82	+94	+106	+118	+129
Group C	+17	+33	+50	+66	+83	+99	+116	+132	+149	+165	+182
Group D	+22	+44	+66	+88	+110	+132	+154	+176	+198	+220	+242
Group E	+27	+53	+80	+106	+133	+159	+186	+212	+239	+265	+292
Group F	+32	+64	+95	+127	+159	+191	+222	+254	+286	+318	+349
Group G	+43	+87	+130	+173	+216	+260	+303	+346	+389	+433	+476
Group H	+54	+108	+161	+215	+269	+323	+376	+430	+484	+538	+591
Group I	+65	+130	+194	+259	+324	+389	+453	+518	+583	+648	+712
Group J	+76	+152	+228	+304	+380	+456	+532	+608	+684	+760	+836
Group K	+87	+174	+261	+348	+435	+522	+609	+696	+783	+870	+957
Group L	+98	+196	+294	+392	+490	+588	+686	+784	+882	+980	+1078
Group M	+109	+219	+328	+437	+546	+656	+765	+874	+983	+1093	+1202
Group N	+120	+241	+361	+481	+601	+722	+842	+962	+1082	+1203	+1323
Group O	+132	+263	+395	+526	+658	+789	+921	+1052	+1184	+1315	+1447
Group P	+142	+285	+427	+569	+711	+854	+996	+1138	+1280	+1423	+1565
Group Q	+164	+328	+492	+656	+820	+984	+1148	+1312	+1476	+1640	+1804
Group R	+229	+458	+687	+916	+1145	+1374	+1603	+1832	+2061	+2290	+2519
Group S	+246	+492	+737	+983	+1229	+1475	+1720	+1966	+2212	+2458	+2703
Group T	+263	+526	+788	+1051	+1314	+1577	+1839	+2102	+2365	+2628	+2890
Group U	+280	+560	+840	+1120	+1400	+1680	+1960	+2240	+2520	+2800	+3080
Group V	+297	+594	+890	+1187	+1484	+1781	+2077	+2374	+2671	+2968	+3264
Group W	+314	+628	+941	+1,255	+1569	+1883	+2196	+2510	+2824	+3138	+3451
Group X	+331	+662	+993	+1,324	+1655	+1986	+2317	+2648	+2979	+3310	+3641
Group Y	+348	+696	+1043	+1,391	+1739	+2087	+2434	+2782	+3130	+3478	+3825
Group Z	+365	+730	+1094	+1,459	+1824	+2189	+2553	+2918	+3283	+3648	+4012

Upholstery Upcharges											
	Yardage Requirement										
Yardage	3	3 1/4	3 1/2	3 3/4	4	4 1/4	4 1/2	4 3/4	5	5 1/4	5 1/2
Sq. Feet	54	58 1/2	63	67 1/2	72	76 1/2	81	85 1/2	90	94 1/2	99
COL	+270	+293	+315	+338	+360	+383	+405	+428	+450	+473	+495
Group 1	+147	+159	+172	+184	+196	+208	+221	+233	+245	+257	+270
Group 2	+177	+192	+207	+221	+236	+251	+266	+280	+295	+310	+325
Group 3	+219	+237	+256	+274	+292	+310	+329	+347	+365	+383	+402
Group 4	+270	+293	+315	+338	+360	+383	+405	+428	+450	+473	+495
Group 5	+393	+426	+459	+491	+524	+557	+590	+622	+655	+688	+721
Group 6	+519	+562	+606	+649	+692	+735	+779	+822	+865	+908	+952
Group 7	+636	+689	+742	+795	+848	+901	+954	+1007	+1060	+1113	+1166
Group 8	+972	+1053	+1134	+1215	+1296	+1377	+1458	+1539	+1620	+1701	+1782
Group 9	+1206	+1307	+1407	+1508	+1608	+1709	+1809	+1910	+2010	+2111	+2211
Group 10	+1389	+1505	+1621	+1736	+1852	+1968	+2084	+2199	+2315	+2431	+2547
Group 11	+1554	+1684	+1813	+1943	+2072	+2202	+2331	+2461	+2590	+2720	+2849
Group 12	+1776	+1924	+2072	+2220	+2368	+2516	+2664	+2812	+2960	+3108	+3256
Group 13	+1836	+1989	+2142	+2295	+2448	+2601	+2754	+2907	+3060	+3213	+3366
Group 14	+2037	+2207	+2377	+2546	+2716	+2886	+3056	+3225	+3395	+3565	+3735
Group A	+123	+133	+144	+154	+164	+174	+185	+195	+205	+215	+226
Group B	+141	+153	+165	+176	+188	+200	+212	+223	+235	+247	+259
Group C	+198	+215	+231	+248	+264	+281	+297	+314	+330	+347	+363
Group D	+264	+286	+308	+330	+352	+374	+396	+418	+440	+462	+484
Group E	+318	+345	+371	+398	+424	+451	+477	+504	+530	+557	+583
Group F	+381	+413	+445	+476	+508	+540	+572	+603	+635	+667	+699
Group G	+519	+562	+606	+649	+692	+735	+779	+822	+865	+908	+952
Group H	+645	+699	+753	+806	+860	+914	+968	+1021	+1075	+1129	+1183
Group I	+777	+842	+907	+971	+1036	+1101	+1166	+1230	+1295	+1360	+1425
Group J	+912	+988	+1064	+1140	+1216	+1292	+1368	+1444	+1520	+1596	+1672
Group K	+1044	+1131	+1218	+1305	+1392	+1479	+1566	+1653	+1740	+1827	+1914
Group L	+1176	+1274	+1372	+1470	+1568	+1666	+1764	+1862	+1960	+2058	+2156
Group M	+1311	+1420	+1530	+1639	+1748	+1857	+1967	+2076	+2185	+2294	+2404
Group N	+1443	+1563	+1684	+1804	+1924	+2044	+2165	+2285	+2405	+2525	+2646
Group O	+1578	+1710	+1841	+1973	+2104	+2236	+2367	+2499	+2630	+2762	+2893
Group P	+1707	+1849	+1992	+2134	+2276	+2418	+2561	+2703	+2845	+2987	+3130
Group Q	+1968	+2132	+2296	+2460	+2624	+2788	+2952	+3116	+3280	+3444	+3608
Group R	+2748	+2977	+3206	+3435	+3664	+3893	+4122	+4351	+4580	+4809	+5038
Group S	+2949	+3195	+3441	+3686	+3932	+4178	+4424	+4669	+4915	+5161	+5407
Group T	+3153	+3416	+3679	+3941	+4204	+4467	+4730	+4992	+5255	+5518	+5781
Group U	+3360	+3640	+3920	+4200	+4480	+4760	+5040	+5320	+5600	+5880	+6160
Group V	+3561	+3858	+4155	+4451	+4748	+5045	+5342	+5638	+5935	+6232	+6529
Group W	+3765	+4079	+4393	+4706	+5020	+5334	+5648	+5961	+6275	+6589	+6903
Group X	+3972	+4303	+4634	+4965	+5296	+5627	+5958	+6289	+6620	+6951	+7282
Group Y	+4173	+4521	+4869	+5216	+5564	+5912	+6260	+6607	+6955	+7303	+7651
Group Z	+4377	+4742	+5107	+5471	+5836	+6201	+6566	+6930	+7295	+7660	+8025

Upholstery Upcharges											
	Yardage Requirement										
Yardage	5 3/4	6	6 1/4	6 1/2	6 3/4	7	7 1/4	7 1/2	7 3/4	8	8 1/4
Sq. Feet	103 1/2	108	112 1/2	117	121 1/2	126	130 1/2	135	139 1/2	144	148 1/2
COL	+518	+540	+563	+585	+608	+630	+653	+675	+698	+720	+743
Group 1	+282	+294	+306	+319	+331	+343	+355	+368	+380	+392	+404
Group 2	+339	+354	+369	+384	+398	+413	+428	+443	+457	+472	+487
Group 3	+420	+438	+456	+475	+493	+511	+529	+548	+566	+584	+602
Group 4	+518	+540	+563	+585	+608	+630	+653	+675	+698	+720	+743
Group 5	+753	+786	+819	+852	+884	+917	+950	+983	+1015	+1048	+1081
Group 6	+995	+1038	+1081	+1125	+1168	+1211	+1254	+1298	+1341	+1384	+1427
Group 7	+1219	+1272	+1325	+1378	+1431	+1484	+1537	+1590	+1643	+1696	+1749
Group 8	+1863	+1944	+2025	+2106	+2187	+2268	+2349	+2430	+2511	+2592	+2673
Group 9	+2312	+2412	+2513	+2613	+2714	+2814	+2915	+3015	+3116	+3216	+3317
Group 10	+2662	+2778	+2894	+3010	+3125	+3241	+3357	+3473	+3588	+3704	+3820
Group 11	+2979	+3108	+3238	+3367	+3497	+3626	+3756	+3885	+4015	+4144	+4274
Group 12	+3404	+3552	+3700	+3848	+3996	+4144	+4292	+4440	+4588	+4736	+4884
Group 13	+3519	+3672	+3825	+3978	+4131	+4284	+4437	+4590	+4743	+4896	+5049
Group 14	+3904	+4074	+4244	+4414	+4583	+4753	+4923	+5093	+5262	+5432	+5602
Group A	+236	+246	+256	+267	+277	+287	+297	+308	+318	+328	+338
Group B	+270	+282	+294	+306	+317	+329	+341	+353	+364	+376	+388
Group C	+380	+396	+413	+429	+446	+462	+479	+495	+512	+528	+545
Group D	+506	+528	+550	+572	+594	+616	+638	+660	+682	+704	+726
Group E	+610	+636	+663	+689	+716	+742	+769	+795	+822	+848	+875
Group F	+730	+762	+794	+826	+857	+889	+921	+953	+984	+1016	+1048
Group G	+995	+1038	+1081	+1125	+1168	+1211	+1254	+1298	+1341	+1384	+1427
Group H	+1236	+1290	+1344	+1398	+1451	+1505	+1559	+1613	+1666	+1720	+1774
Group I	+1489	+1554	+1619	+1684	+1748	+1813	+1878	+1943	+2007	+2072	+2137
Group J	+1748	+1824	+1900	+1976	+2052	+2128	+2204	+2280	+2356	+2432	+2508
Group K	+2001	+2088	+2175	+2262	+2349	+2436	+2523	+2610	+2697	+2784	+2871
Group L	+2254	+2352	+2450	+2548	+2646	+2744	+2842	+2940	+3038	+3136	+3234
Group M	+2513	+2622	+2731	+2841	+2950	+3059	+3168	+3278	+3387	+3496	+3605
Group N	+2766	+2886	+3006	+3127	+3247	+3367	+3487	+3608	+3728	+3848	+3968
Group O	+3025	+3156	+3288	+3419	+3551	+3682	+3814	+3945	+4077	+4208	+4340
Group P	+3272	+3414	+3556	+3699	+3841	+3983	+4125	+4268	+4410	+4552	+4694
Group Q	+3772	+3936	+4100	+4264	+4428	+4592	+4756	+4920	+5084	+5248	+5412
Group R	+5267	+5496	+5725	+5954	+6183	+6412	+6641	+6870	+7099	+7328	+7557
Group S	+5652	+5898	+6144	+6390	+6635	+6881	+7127	+7373	+7618	+7864	+8110
Group T	+6043	+6306	+6569	+6832	+7094	+7357	+7620	+7883	+8145	+8408	+8671
Group U	+6440	+6720	+7000	+7280	+7560	+7840	+8120	+8400	+8680	+8960	+9240
Group V	+6825	+7122	+7419	+7716	+8012	+8309	+8606	+8903	+9199	+9496	+9793
Group W	+7216	+7530	+7844	+8158	+8471	+8785	+9099	+9413	+9726	+10040	+10354
Group X	+7613	+7944	+8275	+8606	+8937	+9268	+9599	+9930	+10261	+10592	+10923
Group Y	+7998	+8346	+8694	+9042	+9389	+9737	+10085	+10433	+10780	+11128	+11476
Group Z	+8389	+8754	+9119	+9484	+9848	+10213	+10578	+10943	+11307	+11672	+12037

Upholstery Upcharges											
	Yardage Requirement										
Yardage	8 1/2	8 3/4	9	9 1/4	9 1/2	9 3/4	10	10 1/4	10 1/2	10 3/4	11
Sq. Feet	153	157 1/2	162	166 1/2	171	175 1/2	180	184 1/2	189	193 1/2	198
COL	+765	+788	+810	+833	+855	+878	+900	+923	+945	+968	+990
Group 1	+417	+429	+441	+453	+466	+478	+490	+502	+515	+527	+539
Group 2	+502	+516	+531	+546	+561	+575	+590	+605	+620	+634	+649
Group 3	+621	+639	+657	+675	+694	+712	+730	+748	+767	+785	+803
Group 4	+765	+788	+810	+833	+855	+878	+900	+923	+945	+968	+990
Group 5	+1114	+1146	+1179	+1212	+1245	+1277	+1310	+1343	+1376	+1408	+1441
Group 6	+1471	+1514	+1557	+1600	+1644	+1687	+1730	+1773	+1817	+1860	+1903
Group 7	+1802	+1855	+1908	+1961	+2014	+2067	+2120	+2173	+2226	+2279	+2332
Group 8	+2754	+2835	+2916	+2997	+3078	+3159	+3240	+3321	+3402	+3483	+3564
Group 9	+3417	+3518	+3618	+3719	+3819	+3920	+4020	+4121	+4221	+4322	+4422
Group 10	+3936	+4051	+4167	+4283	+4399	+4514	+4630	+4746	+4862	+4977	+5093
Group 11	+4403	+4533	+4662	+4792	+4921	+5051	+5180	+5310	+5439	+5569	+5698
Group 12	+5032	+5180	+5328	+5476	+5624	+5772	+5920	+6068	+6216	+6364	+6512
Group 13	+5202	+5355	+5508	+5661	+5814	+5967	+6120	+6273	+6426	+6579	+6732
Group 14	+5772	+5941	+6111	+6281	+6451	+6620	+6790	+6960	+7130	+7299	+7469
Group A	+349	+359	+369	+379	+390	+400	+410	+420	+431	+441	+451
Group B	+400	+411	+423	+435	+447	+458	+470	+482	+494	+505	+517
Group C	+561	+578	+594	+611	+627	+644	+660	+677	+693	+710	+726
Group D	+748	+770	+792	+814	+836	+858	+880	+902	+924	+946	+968
Group E	+901	+928	+954	+981	+1007	+1034	+1060	+1087	+1113	+1140	+1166
Group F	+1080	+1111	+1143	+1175	+1207	+1238	+1270	+1302	+1334	+1365	+1397
Group G	+1471	+1514	+1557	+1600	+1644	+1687	+1730	+1773	+1817	+1860	+1903
Group H	+1828	+1881	+1935	+1989	+2043	+2096	+2150	+2204	+2258	+2311	+2365
Group I	+2202	+2266	+2331	+2396	+2461	+2525	+2590	+2655	+2720	+2784	+2849
Group J	+2584	+2660	+2736	+2812	+2888	+2964	+3040	+3116	+3192	+3268	+3344
Group K	+2958	+3045	+3132	+3219	+3306	+3393	+3480	+3567	+3654	+3741	+3828
Group L	+3332	+3430	+3528	+3626	+3724	+3822	+3920	+4018	+4116	+4214	+4312
Group M	+3715	+3824	+3933	+4042	+4152	+4261	+4370	+4479	+4589	+4698	+4807
Group N	+4089	+4209	+4329	+4449	+4570	+4690	+4810	+4930	+5051	+5171	+5291
Group O	+4471	+4603	+4734	+4866	+4997	+5129	+5260	+5392	+5523	+5655	+5786
Group P	+4837	+4979	+5121	+5263	+5406	+5548	+5690	+5832	+5975	+6117	+6259
Group Q	+5576	+5740	+5904	+6068	+6232	+6396	+6560	+6724	+6888	+7052	+7216
Group R	+7786	+8015	+8244	+8473	+8702	+8931	+9160	+9389	+9618	+9847	+10076
Group S	+8356	+8601	+8847	+9093	+9339	+9584	+9830	+10076	+10322	+10567	+10813
Group T	+8934	+9196	+9459	+9722	+9985	+10247	+10510	+10773	+11036	+11298	+11561
Group U	+9520	+9800	+10080	+10360	+10640	+10920	+11200	+11480	+11760	+12040	+12320
Group V	+10090	+10386	+10683	+10980	+11277	+11573	+11870	+12167	+12464	+12760	+13057
Group W	+10668	+10981	+11295	+11609	+11923	+12236	+12550	+12864	+13178	+13491	+13805
Group X	+11254	+11585	+11916	+12247	+12578	+12909	+13240	+13571	+13902	+14233	+14564
Group Y	+11824	+12171	+12519	+12867	+13215	+13562	+13910	+14258	+14606	+14953	+15301
Group Z	+12402	+12766	+13131	+13496	+13861	+14225	+14590	+14955	+15320	+15684	+16049

Upholstery Upcharges											
	Yardage Requirement										
Yardage	11 1/4	11 1/2	11 3/4	12	12 1/4	12 1/2	12 3/4	13	13 1/4	13 1/2	13 3/4
Sq. Feet	202 1/2	207	211 1/2	216	220 1/2	225	229 1/2	234	238 1/2	243	247 1/2
COL	+1013	+1035	+1058	+1080	+1103	+1125	+1148	+1170	+1193	+1215	+1238
Group 1	+551	+564	+576	+588	+600	+613	+625	+637	+649	+662	+674
Group 2	+664	+679	+693	+708	+723	+738	+752	+767	+782	+797	+811
Group 3	+821	+840	+858	+876	+894	+913	+931	+949	+967	+986	+1004
Group 4	+1013	+1035	+1058	+1080	+1103	+1125	+1148	+1170	+1193	+1215	+1238
Group 5	+1474	+1507	+1539	+1572	+1605	+1638	+1670	+1703	+1736	+1769	+1801
Group 6	+1946	+1990	+2033	+2076	+2119	+2163	+2206	+2249	+2292	+2336	+2379
Group 7	+2385	+2438	+2491	+2544	+2597	+2650	+2703	+2756	+2809	+2862	+2915
Group 8	+3645	+3726	+3807	+3888	+3969	+4050	+4131	+4212	+4293	+4374	+4455
Group 9	+4523	+4623	+4724	+4824	+4925	+5025	+5126	+5226	+5327	+5427	+5528
Group 10	+5209	+5325	+5440	+5556	+5672	+5788	+5903	+6019	+6135	+6251	+6366
Group 11	+5828	+5957	+6087	+6216	+6346	+6475	+6605	+6734	+6864	+6993	+7123
Group 12	+6660	+6808	+6956	+7104	+7252	+7400	+7548	+7696	+7844	+7992	+8140
Group 13	+6885	+7038	+7191	+7344	+7497	+7650	+7803	+7956	+8109	+8262	+8415
Group 14	+7639	+7809	+7978	+8148	+8318	+8488	+8657	+8827	+8997	+9167	+9336
Group A	+461	+472	+482	+492	+502	+513	+523	+533	+543	+554	+564
Group B	+529	+541	+552	+564	+576	+588	+599	+611	+623	+635	+646
Group C	+743	+759	+776	+792	+809	+825	+842	+858	+875	+891	+908
Group D	+990	+1012	+1034	+1056	+1078	+1100	+1122	+1144	+1166	+1188	+1210
Group E	+1193	+1219	+1246	+1272	+1299	+1325	+1352	+1378	+1405	+1431	+1458
Group F	+1429	+1461	+1492	+1524	+1556	+1588	+1619	+1651	+1683	+1715	+1746
Group G	+1946	+1990	+2033	+2076	+2119	+2163	+2206	+2249	+2292	+2336	+2379
Group H	+2419	+2473	+2526	+2580	+2634	+2688	+2741	+2795	+2849	+2903	+2956
Group I	+2914	+2979	+3043	+3108	+3173	+3238	+3302	+3367	+3432	+3497	+3561
Group J	+3420	+3496	+3572	+3648	+3724	+3800	+3876	+3952	+4028	+4104	+4180
Group K	+3915	+4002	+4089	+4176	+4263	+4350	+4437	+4524	+4611	+4698	+4785
Group L	+4410	+4508	+4606	+4704	+4802	+4900	+4998	+5096	+5194	+5292	+5390
Group M	+4916	+5026	+5135	+5244	+5353	+5463	+5572	+5681	+5790	+5900	+6009
Group N	+5411	+5532	+5652	+5772	+5892	+6013	+6133	+6253	+6373	+6494	+6614
Group O	+5918	+6049	+6181	+6312	+6444	+6575	+6707	+6838	+6970	+7101	+7233
Group P	+6401	+6544	+6686	+6828	+6970	+7113	+7255	+7397	+7539	+7682	+7824
Group Q	+7380	+7544	+7708	+7872	+8036	+8200	+8364	+8528	+8692	+8856	+9020
Group R	+10305	+10534	+10763	+10992	+11221	+11450	+11679	+11908	+12137	+12366	+12595
Group S	+11059	+11305	+11550	+11796	+12042	+12288	+12533	+12779	+13025	+13271	+13516
Group T	+11824	+12087	+12349	+12612	+12875	+13138	+13400	+13663	+13926	+14189	+14451
Group U	+12600	+12880	+13160	+13440	+13720	+14000	+14280	+14560	+14840	+15120	+15400
Group V	+13354	+13651	+13947	+14244	+14541	+14838	+15134	+15431	+15728	+16025	+16321
Group W	+14119	+14433	+14746	+15060	+15374	+15688	+16001	+16315	+16629	+16943	+17256
Group X	+14895	+15226	+15557	+15888	+16219	+16550	+16881	+17212	+17543	+17874	+18205
Group Y	+15649	+15997	+16344	+16692	+17040	+17388	+17735	+18083	+18431	+18779	+19126
Group Z	+16414	+16779	+17143	+17508	+17873	+18238	+18602	+18967	+19332	+19697	+20061

Upholstery Upcharges											
	Yardage Requirement										
Yardage	14	14 1/4	14 1/2	14 3/4	15	15 1/4	15 1/2	15 3/4	16	16 1/4	16 1/2
Sq. Feet	252	256 1/2	261	265 1/2	270	274 1/2	279	283 1/2	288	292 1/2	297
COL	+1260	+1283	+1305	+1328	+1350	+1373	+1395	+1418	+1440	+1463	+1485
Group 1	+686	+698	+711	+723	+735	+747	+760	+772	+784	+796	+809
Group 2	+826	+841	+856	+870	+885	+900	+915	+929	+944	+959	+974
Group 3	+1022	+1040	+1059	+1077	+1095	+1113	+1132	+1150	+1168	+1186	+1205
Group 4	+1260	+1283	+1305	+1328	+1350	+1373	+1395	+1418	+1440	+1463	+1485
Group 5	+1834	+1867	+1900	+1932	+1965	+1998	+2031	+2063	+2096	+2129	+2162
Group 6	+2422	+2465	+2509	+2552	+2595	+2638	+2682	+2725	+2768	+2811	+2855
Group 7	+2968	+3021	+3074	+3127	+3180	+3233	+3286	+3339	+3392	+3445	+3498
Group 8	+4536	+4617	+4698	+4779	+4860	+4941	+5022	+5103	+5184	+5265	+5346
Group 9	+5628	+5729	+5829	+5930	+6030	+6131	+6231	+6332	+6432	+6533	+6633
Group 10	+6482	+6598	+6714	+6829	+6945	+7061	+7177	+7292	+7408	+7524	+7640
Group 11	+7252	+7382	+7511	+7641	+7770	+7900	+8029	+8159	+8288	+8418	+8547
Group 12	+8288	+8436	+8584	+8732	+8880	+9028	+9176	+9324	+9472	+9620	+9768
Group 13	+8568	+8721	+8874	+9027	+9180	+9333	+9486	+9639	+9792	+9945	+10098
Group 14	+9506	+9676	+9846	+10015	+10185	+10355	+10525	+10694	+10864	+11034	+11204
Group A	+574	+584	+595	+605	+615	+625	+636	+646	+656	+666	+677
Group B	+658	+670	+682	+693	+705	+717	+729	+740	+752	+764	+776
Group C	+924	+941	+957	+974	+990	+1007	+1023	+1040	+1056	+1073	+1089
Group D	+1232	+1254	+1276	+1298	+1320	+1342	+1364	+1386	+1408	+1430	+1452
Group E	+1484	+1511	+1537	+1564	+1590	+1617	+1643	+1670	+1696	+1723	+1749
Group F	+1778	+1810	+1842	+1873	+1905	+1937	+1969	+2000	+2032	+2064	+2096
Group G	+2422	+2465	+2509	+2552	+2595	+2638	+2682	+2725	+2768	+2811	+2855
Group H	+3010	+3064	+3118	+3171	+3225	+3279	+3333	+3386	+3440	+3494	+3548
Group I	+3626	+3691	+3756	+3820	+3885	+3950	+4015	+4079	+4144	+4209	+4274
Group J	+4256	+4332	+4408	+4484	+4560	+4636	+4712	+4788	+4864	+4940	+5016
Group K	+4872	+4959	+5046	+5133	+5220	+5307	+5394	+5481	+5568	+5655	+5742
Group L	+5488	+5586	+5684	+5782	+5880	+5978	+6076	+6174	+6272	+6370	+6468
Group M	+6118	+6227	+6337	+6446	+6555	+6664	+6774	+6883	+6992	+7101	+7211
Group N	+6734	+6854	+6975	+7095	+7215	+7335	+7456	+7576	+7696	+7816	+7937
Group O	+7364	+7496	+7627	+7759	+7890	+8022	+8153	+8285	+8416	+8548	+8679
Group P	+7966	+8108	+8251	+8393	+8535	+8677	+8820	+8962	+9104	+9246	+9389
Group Q	+9184	+9348	+9512	+9676	+9840	+10004	+10168	+10332	+10496	+10660	+10824
Group R	+12824	+13053	+13282	+13511	+13740	+13969	+14198	+14427	+14656	+14885	+15114
Group S	+13762	+14008	+14254	+14499	+14745	+14991	+15237	+15482	+15728	+15974	+16220
Group T	+14714	+14977	+15240	+15502	+15765	+16028	+16291	+16553	+16816	+17079	+17342
Group U	+15680	+15960	+16240	+16520	+16800	+17080	+17360	+17640	+17920	+18200	+18480
Group V	+16618	+16915	+17212	+17508	+17805	+18102	+18399	+18695	+18992	+19289	+19586
Group W	+17570	+17884	+18198	+18511	+18825	+19139	+19453	+19766	+20080	+20394	+20708
Group X	+18536	+18867	+19198	+19529	+19860	+20191	+20522	+20853	+21184	+21515	+21846
Group Y	+19474	+19822	+20170	+20517	+20865	+21213	+21561	+21908	+22256	+22604	+22952
Group Z	+20426	+20791	+21156	+21520	+21885	+22250	+22615	+22979	+23344	+23709	+24074

Upholstery Upcharges											
	Yardage Requirement										
Yardage	17	17 1/4	17 1/2	17 3/4	18	18 1/4	18 1/2	18 3/4	19	19 1/4	19 1/2
Sq. Feet	306	310 1/2	315	319 1/2	324	328 1/2	333	337 1/2	342	346 1/2	351
COL	+1530	+1553	+1575	+1598	+1620	+1643	+1665	+1688	+1710	+1733	+1755
Group 1	+833	+845	+858	+870	+882	+894	+907	+919	+931	+943	+956
Group 2	+1003	+1018	+1033	+1047	+1062	+1077	+1092	+1106	+1121	+1136	+1151
Group 3	+1241	+1259	+1278	+1296	+1314	+1332	+1351	+1369	+1387	+1405	+1424
Group 4	+1530	+1553	+1575	+1598	+1620	+1643	+1665	+1688	+1710	+1733	+1755
Group 5	+2227	+2260	+2293	+2325	+2358	+2391	+2424	+2456	+2489	+2522	+2555
Group 6	+2941	+2984	+3028	+3071	+3114	+3157	+3201	+3244	+3287	+3330	+3374
Group 7	+3604	+3657	+3710	+3763	+3816	+3869	+3922	+3975	+4028	+4081	+4134
Group 8	+5508	+5589	+5670	+5751	+5832	+5913	+5994	+6075	+6156	+6237	+6318
Group 9	+6834	+6935	+7035	+7136	+7236	+7337	+7437	+7538	+7638	+7739	+7839
Group 10	+7871	+7987	+8103	+8218	+8334	+8450	+8566	+8681	+8797	+8913	+9029
Group 11	+8806	+8936	+9065	+9195	+9324	+9454	+9583	+9713	+9842	+9972	+10101
Group 12	+10064	+10212	+10360	+10508	+10656	+10804	+10952	+11100	+11248	+11396	+11544
Group 13	+10404	+10557	+10710	+10863	+11016	+11169	+11322	+11475	+11628	+11781	+11934
Group 14	+11543	+11713	+11883	+12052	+12222	+12392	+12562	+12731	+12901	+13071	+13241
Group A	+697	+707	+718	+728	+738	+748	+759	+769	+779	+789	+800
Group B	+799	+811	+823	+834	+846	+858	+870	+881	+893	+905	+917
Group C	+1122	+1139	+1155	+1172	+1188	+1205	+1221	+1238	+1254	+1271	+1287
Group D	+1496	+1518	+1540	+1562	+1584	+1606	+1628	+1650	+1672	+1694	+1716
Group E	+1802	+1829	+1855	+1882	+1908	+1935	+1961	+1988	+2014	+2041	+2067
Group F	+2159	+2191	+2223	+2254	+2286	+2318	+2350	+2381	+2413	+2445	+2477
Group G	+2941	+2984	+3028	+3071	+3114	+3157	+3201	+3244	+3287	+3330	+3374
Group H	+3655	+3709	+3763	+3816	+3870	+3924	+3978	+4031	+4085	+4139	+4193
Group I	+4403	+4468	+4533	+4597	+4662	+4727	+4792	+4856	+4921	+4986	+5051
Group J	+5168	+5244	+5320	+5396	+5472	+5548	+5624	+5700	+5776	+5852	+5928
Group K	+5916	+6003	+6090	+6177	+6264	+6351	+6438	+6525	+6612	+6699	+6786
Group L	+6664	+6762	+6860	+6958	+7056	+7154	+7252	+7350	+7448	+7546	+7644
Group M	+7429	+7538	+7648	+7757	+7866	+7975	+8085	+8194	+8303	+8412	+8522
Group N	+8177	+8297	+8418	+8538	+8658	+8778	+8899	+9019	+9139	+9259	+9380
Group O	+8942	+9074	+9205	+9337	+9468	+9600	+9731	+9863	+9994	+10126	+10257
Group P	+9673	+9815	+9958	+10100	+10242	+10384	+10527	+10669	+10811	+10953	+11096
Group Q	+11152	+11316	+11480	+11644	+11808	+11972	+12136	+12300	+12464	+12628	+12792
Group R	+15572	+15801	+16030	+16259	+16488	+16717	+16946	+17175	+17404	+17633	+17862
Group S	+16711	+16957	+17203	+17448	+17694	+17940	+18186	+18431	+18677	+18923	+19169
Group T	+17867	+18130	+18393	+18655	+18918	+19181	+19444	+19706	+19969	+20232	+20495
Group U	+19040	+19320	+19600	+19880	+20160	+20440	+20720	+21000	+21280	+21560	+21840
Group V	+20179	+20476	+20773	+21069	+21366	+21663	+21960	+22256	+22553	+22850	+23147
Group W	+21335	+21649	+21963	+22276	+22590	+22904	+23218	+23531	+23845	+24159	+24473
Group X	+22508	+22839	+23170	+23501	+23832	+24163	+24494	+24825	+25156	+25487	+25818
Group Y	+23647	+23995	+24343	+24690	+25038	+25386	+25734	+26081	+26429	+26777	+27125
Group Z	+24803	+25168	+25533	+25897	+26262	+26627	+26992	+27356	+27721	+28086	+28451

Upholstery Application Chart

A - approved
 X - disapproved
 1 - cane back version only
 2 - additional seams required
 3 - armless version only
 blank - untested

Textile	Price Group	Brabo (Back and Seat)	Bumper	Clamshell	Crosshatch	Full Loop	Mantle	Rapport	Rapport Pillows	Reframe High-Back	Reframe Mid-Back	Reframe Wing-Back	Rolled Arm	Saiba	Scissor	Sled	Tuxedo Non Quilted	Tuxedo Quilted	U-Series
A Band Apart	Q	A	X	A	A	X	X	X	X	X	X	X	X	X	A	X	A	X	X
Abacus	H	A	2	A	A	X	X	X	X	X	X	X	A	X	A	A	A	X	A
Agency	Q	A	X	A	A	X	X	X	X	X	X	X	A	X	A	X	A	X	A
All Grain Leather	R	A	A	A	A	A		A	X				A		A	A	A	A	A
Allusion	8	A	X	A	A	X	X	X	X	X	X	X	A	X	A	X	A	X	A
Alpaca Epinglé	N	A	X	A	A	X	X	X	X	X	X	X	A	X	A	X	X	X	A
Alpaca Mohair	9	A	X	A	A	X	X	X	X	X	X	X	A	X	A	A	X	X	X
Alpaca Velvet	N	A	X	A	A	X	X	X	X	X	X	X	A	X	A	A	X	X	A
Amenia	7	A	A	A	A	A	X	A	A	X	X	X	A	A	A	A	A	A	A
Anagram	H	A	X	A	A	X	X	X	X	X	X	X	X	X	A	X	A	X	X
Antico	4	A	A	A	A	X	X	A	A	A	A	X	A	A	A	A	A	A	A
Apt	F	A	A	A	A	X		X	X				A	A	A	X	A	X	A
Article	E	A	A	A	A	X	A	A	X				A		A	A	A	A	A
Basketweave	8	A	A	A	A	A	A	A	A				A		A	A	A	A	A
Bavaria Stripe	O	A	X	A	A	X	X	X	X	X	X	X	X	X	A	X	X	X	X
Bavaria Unique	S	A	X	A	A	X	X	X	X	X	X	X	X	X	A	X	X		
Bellano	7	A	A	A	A	A	A	A	A	A	A	A	A	A	A	A	A	A	A
Bespoke Stripe	N	A	X	A	A	X	X	X	X	X	X	X	X	X	A	X	X	X	X
Big Foot Leather	Z	A	A	A	A	A		A	X				A		A	A	A	A	A
Big Stripe	P	A	X	A	A	X	X	X	X	X	X	X	X	X	A	X	X	X	X
Blumen	L	A	X	A	A	X	X	X	X	X	X	X	X	X	A	X	A	X	X
Borders	R	A	X	A	A	X	X	X	X	X	X	X	A	X	A	X	A	X	X
Bouclé	5	A	A	A	A	A	A	X	A	A	A	A	A	A	A	X	A	X	A
Braid	4	A	2	A	A	A		A	A				A	A	A	A	A	A	A
Brindle	F	A	X	A	A	A		A	A				A	X	A	A	A	A	A
Bristol Leather	10	A	A	A	A	A	A	A	A	A	A	X	A	A	A	A	A	A	A
Brushed Camel	Q	A	A	A	A	A	A	A	A				A		A	A	A	A	A
Brushed Merino	P	A	A	A	A	A													
Button-Up	5	A	A	A	A		X	A	A	A	A	X	A	A	A	A	A	A	A
Cambrai	3	A	A	A	A	A	X	A	A	A	A	X	A	A	A	A	A	A	A

Upholstery Application Chart

A - approved
 X - disapproved
 1 - cane back version only
 2 - additional seams required
 3- armless version only
 blank - untested

Textile	Price Group	Brabo (Back and Seat)	Bumper	Clamshell	Crosshatch	Full Loop	Mantle	Rapport	Rapport Pillows	Reframe High-Back	Reframe Mid-Back	Reframe Wing-Back	Rolled Arm	Saiba	Scissor	Sled	Tuxedo Non Quilted	Tuxedo Quilted	U-Series
Canon	2	A	A	A	A	A	X	A	A	A	A	X	A	X	A	A	A	A	A
Capri	7	A	A	A	A	A	A	A	A	A	A	A	A	A	A	X	A	A	A
Checker	K	A	A	A	A	X		X	X						A	X	A	X	A
Checker Split	K	A	X	A	A	X	X	X	X	X	X	X	X	X	A	A	A	X	A
Cheswick	5	A	A	A	A	X	X	X	X	X	X	X	A	X	A	X	A	A	A
Chime	F	A	A	A	A	A	A	A	A	A	A	A	A	A	A	A	A	A	A
Circuit	G	A	A	A	A	X	X	X	X	X	X	X	X	X	X	X	A	X	X
Claremont	5	A	A	A	A	A	X	A	A	X	X	X	A	X	A	A	A	A	A
Classic Velvet	6	A	A	A	A	X	X	X	X	X	X	X	A	X	A	X	X	X	A
Coach Cloth	J	A	A	A	A	X	X	X	X	X	X	X	A	X	A	X	X	X	A
Compartment	R	A	X	A	A	X	X	X	X	X	X	X	X	X	X	X	A	X	X
Compound	G	A	A	A	A	X	X	A	X	A	A	A	A	X	A	A	A	A	A
Corded Stripe	9	A	X	A	A	X	X	X	X	X	X	X	X	X	A	X	A	X	X
Crew	G	A	A	A	A	X	X	X	X	X	X	X	X	X	A	X	A	X	X
Crush	F	A	A	A	A	A		X	X				A	X	A	A	A	X	A
Dapper	5	A	2	A	A	A		X	X				X		A	A	A	A	A
Deconstructed Rose	Q	A	X	A	A	X	X	X	X	X	X	X	X	X	A	X	A	X	X
Design 9297	J	A	X	A	A	X	X	X	X	X	X	X	X	X	A	X	A	X	X
Dingbats	K	A	X	A	A	X	X	X	X	X	X	X	X	X	A	X	A	X	X
Dorset	7	A	A	A	A	A	A	A	A	X	X	X	A	A	A	A	A	A	A
Double Beam Redux	7	A	A	A	A	X		A	A				A	X	A	A	A	A	A
Double Triangles	K	A	X	A	A	X	X	X	X	X	X	X	X	X	A	X	A	X	X
Drape		A	X	A	A	X	X	X	X	X	X	X	X	X	A	X	A	X	X
Dream Cow Leather	R	A	A	A	A	A		A	X				A		A	A	A	A	A
Dwell	E	A	X	A	A	X	X	X	X	X	X	X	A	X	A	X	X	X	A
EcoHide Classic	4	A	A	A	A	X		A	X	A	A		A	A	A	X	A	X	A
Envie	5	A	A	A	A	A	A	A	A	A	A	A	A	A	A	X	A	A	A
Epinglé	7	A	A	A	A	A	X	X	X				A		A	A	A	A	A
Epinglé Stripe	P	A	X	A	A	X	X	X	X	X	X	X	X	X	A	X	A	X	X
Essential Twill	5	A	X	A	A	A	X	X	X				A	X	A	A	A	A	A

Upholstery Application Chart

A - approved
 X - disapproved
 1 - cane back version only
 2 - additional seams required
 3 - armless version only
 blank - untested

Textile	Price Group	Brabo (Back and Seat)	Bumper	Clamshell	Crosshatch	Full Loop	Mantle	Rapport	Rapport Pillows	Reframe High-Back	Reframe Mid-Back	Reframe Wing-Back	Rolled Arm	Saiba	Scissor	Sled	Tuxedo Non Quilted	Tuxedo Quilted	U-Series
Even	2	A	A	A	A	A	X	A	A	X	X	X	A	X	A	A	A	A	A
Exaggerated Plaid	L	A	X	A	A	X	X	X	X	X	X	X	X	X	A	X	A	X	X
Facets	K	A	X	A	A	X	X	X	X	X	X	X	X	X	A	X	A	X	X
Fluent Crypton	G	A	A	A	A	X	X	X	X	X	X	X	A	X	A	X	A	X	X
Foot Hills	8	A	X	A	A	X	X	X	X	X	X	X	X	X	A	X	A	A	A
Free Range Leather	V	A	A	A	A	A		A	X				A		A	A	A	X	A
Fringe	4	A	2	A	A	A		X					X		A	X	A	X	X
Garden	I	A	X	A	A	X	X	X	X	X	X	X	X	X	A	X	A	X	X
Gemma	9	A	A	A	A	A	A	A	A	A	A	A	A	A	A	A	A		
Gemma Multi	10	A	A	A	A	A	A	A	A	A	A	A	A	A	A	A	A		
Geometri	L	A	X	A	A	X	X	X	X	X	X	X	X	X	A	X	A	X	X
Granno	4	A	A	A	A	X	X	A	X	X	X	X	A	X	A	A	A	A	A
Graphon	7	A	X	A	A	A	X	X	X	X	X	X	X	X	A	X	A	X	X
Gridwork	6	A	X	A	A	X		X	X				X	X	A	A	A	X	X
Harlow	5	A	A	A	A	A		A	A	A	A	X	A	A	A	A	A	A	A
Herringbone	5	A	2	A	A	X	X	X	X	X	X	X	X	X	A	X	A	X	X
Herringbone Stripe	N	A	X	A	A	X	X	X	X	X	X	X	X	X	A	X	A	X	X
Hopsak	5	A	A	A	A	A	X	A	A	A	A	A	A	A	A	A	A	A	A
Houndstooth Check	5	A	A	A	A	X	X	X	X	X	X	X	A	X	A	X	A	X	
Hours	T	A	X	A	A	X	X	X	X	X	X	X	X	X	A	X	A	X	
Ingenua	5	A	A	A	A	A	A	A	A	A	A	A	A	A	A	A	A	A	A
Instill	F	A	A	A	A	X		A	A				A	X	A	A	A	A	A
Iota	5	A	A	A	A	A	A	A	A	A	A		A	A	A	A	A	A	A
Iron Cloth	5	A	X	A	A	A	X	X	X	X	X	X	X	X	A	X	X	X	X
Irregular Grid	4	A	X	A	A	X	X	X	X	X	X	X	X	X	A	X	A	X	X
Jacobs Coat	L	A	X	A	A	X	X	X	X	X	X	X	X	X	A	X	A	X	X
Kalista	4	A	A	A	A	A	X	A	A	A	A	A	A	A	A	A	A	A	A
Lanalux	14	A	A	A	A	A	A	A	A	A	A	A	A		A	A	A	A	A
Lariat	E	A	A	A	A	X	X	A	A	A	A	A	A	A	A	A	A	A	A
Layers Garden	P	A	X	A	A	X	X	X	X	X	X	X	X	X	A	X	A	X	X

Upholstery Application Chart

A - approved
 X - disapproved
 1 - cane back version only
 2 - additional seams required
 3- armless version only
 blank - untested

Textile	Price Group	Brabo (Back and Seat)	Bumper	Clamshell	Crosshatch	Full Loop	Mantle	Rapport	Rapport Pillows	Reframe High-Back	Reframe Mid-Back	Reframe Wing-Back	Rolled Arm	Saiba	Scissor	Sled	Tuxedo Non Quilted	Tuxedo Quilted	U-Series
Layers Garden Double	U	A	X	A	A	X	X	X	X	X	X	X	X	X	A	X	A	X	X
Layers Park	P	A	X	A	A	X	X	X	X	X	X	X	X	X	A	X	A	X	X
Layers Park Double	U	A	X	A	A	X	X	X	X	X	X	X	X	X	A	X	A	X	X
Layers Vineyard Large	P	A	X	A	A	X	X	X	X	X	X	X	X	X	A	X	A	X	X
Layers Vineyard Small	P	A	X	A	A	X	X	X	X	X	X	X	X	X	A	X	A	X	X
Ledger	E	A	A	A	A	X		A	X	A	A		A		A	A	A	A	A
Lucio	5	A	X	A	A	X	X	X	X	X	X	X	A	X	A	X		X	A
Manner	C	A	A	A	A	A	X	A	A	A	A	A	A	A	A	A	A	A	A
Massive Paisley	Q	A	X	A	A	X	X	X	X	X	X	X	X	X	A	X	A	X	X
Mechanism	H	A	X	A	A	X	X	X	X	X	X	X	X	X	A	X	X	X	X
Meld	3	A	A	A	A	A	X	A	A	A	A	A	A	A	A	A	A	A	A
Metallic Dream Cow Leather	R	A	A	A	A	A		A	X				A	X	A	A	A	A	A
Metric	E	A	A	A	A	A	X	A	A	X	X	X	A	A	A	A	A	A	A
Micro	E	A	A	A	A	X		A	A	X	X	X	A		A	A	A	A	A
Micro Houndstooth	4	A	A	A	A	X	X	X	X	X	X	X	A	X	A	X	A	X	A
Milaner	7	A	A	A	A	A	X	X	X	A	A	A	A	A	A	X	A	A	A
Milestone	C	A	A	A	A	A		A	A				A	A	A	A	A	A	A
Millerstripe	L	A	X	A	A	X	X	X	X	X	X	X	X	X	A	X	A	X	X
Mimic	G	A	A	A	A	X	X	A	X				A		A	A	A	A	A
Mini Plaid	3	A	X	A	A	X	X	X	X	X	X	X	A	X	A	X	A	X	A
Mister	H	A	X	A	A	X	X	X	X	X	X	X	A		A	X	A	X	A
Mode	D	A	A	A	A	A	A	A	A	A	A	X	A	A	A	A	A	A	A
Mohair Supreme	P	A	A	A	A	X	X	X	X	X	X	X	A	X	A	X	A	X	A
Murmur	C	A	A	A	A	A		A	A				A	A	A	A	A	A	A
Novello	4	A	A	A	A	X		A	X	X	X	X	A	X	A	A	A	A	A
Offset	H	A	X	A	A	X	X	X	X	X	X	X	A	X	A	X	A	X	A
Optik	K	A	X	A	A	X	X	X	X	X	X	X	A	X	A	X	A	X	X
Orakelblume	K	A	X	A	A	X	X	X	X	X	X	X	A	X	A	X	A	X	X
Ottoman	4	A	A	A	A	A	A	A	A				A	A	A	A	A	A	A
Ottoman Stripe	M	A	X	A	A	X	X	X	X	X	X	X	X	X	A	X	A	X	X

Upholstery Application Chart

A - approved
 X - disapproved
 1 - cane back version only
 2 - additional seams required
 3- armless version only
 blank - untested

Textile	Price Group	Brabo (Back and Seat)	Bumper	Clamshell	Crosshatch	Full Loop	Mantle	Rapport	Rapport Pillows	Reframe High-Back	Reframe Mid-Back	Reframe Wing-Back	Rolled Arm	Saiba	Scissor	Sled	Tuxedo Non Quilted	Tuxedo Quilted	U-Series
Overture	6	A	A	A	A	A	A	A	A				A	A	A	A	A	A	A
Painted Stripe	K	A	X	A	A	X	X	X	X	X	X	X	X	X	A	X	A	X	X
Panno Di Dolce	7	A	A	A	A	A	A	A	A	A	A	A	A	A	A	A	A	A	A
Pantile	7	A	X	A	A	A		X	X				A	X	A	A	A	A	A
Pare	G	A	A	A	A	A		A	A	A	A	A	A	A	A	A	A	A	A
Piccolo	4	A	A	A	A	A	X	A	A	A	A		A	A	A	X	A	A	
Pick-Stitch Plaid	6	A	X	A	A	X	X	X	X	X	X	X	X	X	A	X	A	X	X
Pinpoint	3	A	A	A	A	X	X	X	X	X	X	X	X	X	A	X	A	X	X
Pitch	F	A	A	A	A	X		A	X				A	X	A	A	A	A	A
Point	N	A	X	A	A	X	X	X	X	X	X	X	X	X	A	X	A	X	X
Pristina	7	A	A	A	A	A	A	A	A	A	A	A	A	A	A	A	A	A	A
Regatta	H	A	X	A	A	X	X	X	X	X	X	X	X	X	A	X	A	X	X
Renata	7	A	A	A	A	A	A	A	A	A	A	X	A	A	A	A	A	A	A
Repeat Classic Stripe	L	A	A	A	A	X	X	X	X	X	X	X	X	X	A	X	A	X	X
Resca	7	A	A	A	A	A	X	X	X	A	A		X	A	A	X	A	X	X
Rule	H	A	X	A	A	X	X	X	X	X	X	X	X	X	A	X	A	A	X
Runner	G	A	X	A	A	X	X	X	X	X	X	X	X	X	A	X	A	X	X
Runner Standard	F	A	X	A	A	X	X	X	X	X	X	X	X	X	A	X	A	X	X
Saille	3	A	A	A	A	A	X	A	A			A	A	A	A	A	A	A	A
Sateen Weave	7	A	A	A	A	A		X	A	A	A	A	A	A	A	X	A	X	A
Scuba	F	A	A	A	A	X	X	A	X	X	X	X	A	X	A	A	A	A	A
Semplice Leather	8	A	A	A	A	A		A	A	X	X	X	A	A	A	A	A	A	A
Sequence	G	A	X	A	A	X	X	X	X	X	X	X	X	X	A	X	A	X	X
Soft Tweed	J	A	X	A	A	X	X	X	X	X	X	X	X	X	A	X	A	X	X
Sommar	6	A	A	A	A	A		X	X				A	X	A	A	A	A	A
Staple	8	A	A	A	A	X	X	X	X	X	X	X	A	X	A	X	A	X	A
Starlet	8	A	A	A	A	A	X	A	A	X	X	X	A	A	A	A	A	A	A
Striae	5	A	X	A	A	X	X	X	X	X	X	X	X	X	A	X	A	X	X
Stripes	L	A	X	A	A	X	X	X	X	X	X	X	X	X	A	X	ý	X	X
Striscia	8	A	X	A	A	X	X	X	X	X	X	X	X	X	A	X	A	X	X

Upholstery Application Chart

A - approved
 X - disapproved
 1 - cane back version only
 2 - additional seams required
 3- armless version only
 blank - untested

Textile	Price Group	Brabo (Back and Seat)	Bumper	Clamshell	Crosshatch	Full Loop	Mantle	Rapport	Rapport Pillows	Reframe High-Back	Reframe Mid-Back	Reframe Wing-Back	Rolled Arm	Saiba	Scissor	Sled	Tuxedo Non Quilted	Tuxedo Quilted	U-Series
Strum	F	A	A	A	A	X	X	X	X				A		A	A	A	A	A
Sudden	G	A	A	A	A	X	X	X	X				A		A	A	A	A	A
Superweave	10	A	A	A	A	A		A	A				A		A	A	A	A	A
Tangram	J	A	X	A	A	X	X	X	X	X	X	X	X	X	A	X	A	X	X
Tattersall Reverse	6	A	X	A	A	X	X	X	X	X	X	X	X	X	A	X	A	X	X
Tenera Leather	11	A	A	A	A	A	X	A	X	A	A		A	A	A	A	A	A	A
Tenon	5	A	A	A	A	A	X	A	A	A	A	A	A	A	A	A	A	A	A
The Firm	Q	A	X	A	A	X	X	X	X	X	X	X	X	X	A	X	A	X	X
The Story of My Life	L	A	X	A	A	X	X	X	X	X	X	X	X	X	A	X	A	X	X
Toostripe	L	A	X	A	A	X	X	X	X	X	X	X	X	X	A	X	A	X	X
True Herringbone	7	A	A	A	A	A	X	X	X	X	X	X	X	X	A	X	A	X	X
Twill Plaid	7	A	X	A	A	X	X	X	X	X	X	X	X	X	A	X	A	X	X
Twist	2	A	A	A	A	A		A	A	A	A		A	A	A	A	A	A	A
Unisol	K	A	X	A	A	X	X	X	X	X	X	X	X	X	A	X	A	X	X
Vases	I	A	X	A	A	X	X	X	X	X	X	X	X	X	A	X	A	X	X
Vavare	5	A	X	A	A	A		A	A				A	X	A	X	A	A	A
Vesture	7	A	A	A	A	X	A	A	A	A	A		A		A	A	A	X	A
Vineyard	I	A	X	A	A	X	X	X	X	X	X	X	X	X	A	X	A	X	X
Vionette	5	A	A	A	A	A	X	A	A	A	A	X	A	A	A	A	A	A	A
Voyage	I	A	A	A	A	A		X	X				A		A	A	A	A	A
Wool Epinglé	7	A	A	A	A	A	X	X	X				A		A	A	A	A	A
Wool Velvet	N	A	A	A	A	X	X	X	X	X	X	X	A	X	A	X	X	X	A

Wood Finishes						
Code	Description	Ash	Walnut	Rolled Arm	Tuxedo	Notes
662	Toasted Walnut, matte	•	•	W	W	Brabo has a metal and solid ash or walnut wood frame. When a stained wood finish is specified, the solid ash or walnut wood is stained to match the color of the selected finish.
663	Charred Walnut, matte	•	•	W	W	
664	Bronzed Walnut, matte	•	•	W	W	
665	Smoked Walnut, matte	•	•	W	W	Clamshell has a veneered molded plywood back in either ash or walnut. When a stained wood finish is specified, the veneer is stained to match the color of the selected finish.
666	Coffee Walnut, matte	•	•	W	W	
667	Smoked Paldao, matte	•	•	W	W	
669	Warm Paldao, matte	•	•	W	W	Crosshatch and Reframe have a solid ash or walnut wood frame. When a stained wood finish is specified, the solid ash or walnut wood is stained to match the color of the selected finish.
677	Chocolate Ash, matte	•		A	A	
66A	RecoGrain Frosty Ash, matte	•		A	A	
66W	RecoGrain Walnut, Matte	•		A	A	Rolled Arm legs are either solid ash or walnut. When a stained wood finish is specified, the table is stained to match the color of the selected finish. The solid used is either ash (A) or walnut (W) depending on the finish selected.
68R	RecoGrain Rosewood, matte	•	•	W	W	
68W	RecoGrain Walnut, Matte	•		A	A	
69A	RecoGrain Frosty Ash, matte	•		A	A	Scissor has a metal or solid ash wood frame. When a stained wood finish is specified, the solid ash wood is stained to match the color of the selected finish.
69R	RecoGrain Rosewood, matte	•	•	W	W	
69T	RecoGrain Teak, matte	•		A	A	
69W	RecoGrain Walnut, Matte	•		A	A	Tuxedo side tables have an ash or walnut wood table. When a stained wood finish is specified, the table is stained to match the color of the selected finish. The veneer used is either ash (A) or walnut (W) depending on the finish selected.
6A1	White Ash, matte	•		A	A	
6ET	RecoGrain Natural Ash, Ash Solid, matte	•		A	A	
6EU	RecoGrain Oak, Oak Solid, matte	•		A	A	Appropriate hardwoods are selected to provide a product that will stand up to normal office use and perform under Geiger's 12-year warranty. In certain situations other hardwoods may be appropriate and Geiger will evaluate their use for orders over 100 units.
6EV	RecoGrain Walnut, Walnut Solid, matte	•	•	W	W	
6K1	Rift Oak, matte	•		A	A	
6K6	Burnt Oak, matte	•		A	A	Special finishes can be developed for seating on a minimum order of 100 chairs at no additional charge. For seating orders under 100 chairs, special finishes may be developed for a one-time set-up fee of \$250 net per finish.
940	Sundance Cherry on Maple, low sheen	•		A	A	
943	Caramel Cherry, low sheen	•		A	A	
946	Cocoa Cherry, Low Sheen	•		A	A	For additional information and procedures for special hardwoods or finishes, contact your Geiger sales representative or Geiger Customer Care at 800.456.6452.
956	Cocoa Sapele, low sheen	•		A	A	
962	Toasted Walnut, low sheen	•	•	W	W	
963	Charred Walnut, low sheen	•	•	W	W	
964	Bronzed Walnut, low sheen	•	•	W	W	
965	Smoked Walnut, low sheen	•	•	W	W	
966	Coffee Walnut, low sheen	•	•	W	W	
967	Smoked Paldao, low sheen	•	•	W	W	
969	Warm Paldao, low sheen	•	•	W	W	
972	Sundance Walnut, low sheen		•	W	W	
977	Chocolate Ash, low sheen	•		A	A	
991	Champagne Ash, low sheen	•		A	A	
998	Ebony Ash, low sheen	•		A	A	
96A	RecoGrain Frosty Ash, low sheen	•		A	A	
96W	RecoGrain Walnut, Low Sheen	•		A	A	
98R	RecoGrain Rosewood, low sheen	•	•	W	W	
98W	RecoGrain Walnut, Low Sheen	•		A	A	
99A	RecoGrain Frosty Ash, low sheen	•		A	A	

Wood Finishes

Code	Description	Ash	Walnut	Rolled Arm	Tuxedo
99R	RecoGrain Rosewood, low sheen	•	•	W	W
99T	RecoGrain Teak, low sheen	•		A	A
99W	RecoGrain Walnut, Low Sheen	•		A	A
9A1	White Ash, low sheen	•		A	A
9K1	Rift Oak, low sheen	•		A	A
9K6	Burnt Oak, low sheen	•		A	A
ED	Aged Cherry, low sheen	•		A	A
EK	Medium Red Walnut, low sheen	•	•	W	W
ET	RecoGrain Ash, matte	•		A	A
EU	RecoGrain Oak, matte	•		A	A
EV	RecoGrain Walnut, matte	•	•	W	W
G2U	Light Brown Walnut, low sheen	•	•	W	W
G40	Dark Brown Walnut, low sheen	•	•	W	W
GOU	Walnut, matte	•	•	W	W
UX	Walnut On Cherry, low sheen	•		A	A

	Product Number	Depth	Width	Height	Basic Price	Upholstery
Brabo • Lounge Chair 	ash frame SVV4A	33	26 5/8	29 1/4	\$3,668	<i>Basic/COM Price does not include fabric. Refer to the upholstery upcharge pages for fabric and COL pricing. 1 yard = 18 sq. ft.</i>
	walnut frame SVV4W	33	26 5/8	29 1/4	\$4,395	
<p>COM/COL (Seat and Back) 2 yards, 36 sq. ft. COM/COL (Sling and Arm) 1.5 yards Wood Frame solid ash or walnut Metal Frame steel plated Seat height 15 1/8" Arm height 22" Seat HR foam, Dacron, and polyfoam cushions</p> <p>Note: COM/COL is not available on Brabo sling and arm. Sling and arm are ONLY available in Bristol, MCL, or Tenera Leather. COM/COL requirements provided only for pricing lookup for Bristol, MCL, and Tenera leathers in the upholstery pricing section.</p>						

Specify

- Wood
- Upholstery 1 (back and seat cushion)
- Upholstery 2 (sling and arm leather, only available in Bristol, MCL, and Tenera leather)
- Base Finish
- Fire Retardancy (specify NOCAL)

	Product Number	Depth	Width	Height	Basic Price	Upholstery
Brabo • Settee 	ash frame SVV5A	33	50 5/8	29 1/4	\$6,573	<i>Basic/COM Price does not include fabric. Refer to the upholstery upcharge pages for fabric and COL pricing. 1 yard = 18 sq. ft.</i> <i>Add fabric upcharges for both seat/back and sling/arm.</i>
	walnut frame SVV5W	33	50 5/8	29 1/4	\$6,861	
<p>COM/COL (Seat and Back) 4 yards, 72 sq. ft. COM/COL (Sling and Arm) 3 yards Wood Frame solid ash or walnut Metal Frame steel plated Seat height 15 1/8" Arm height 22 Seat HR foam, Dacron, and polyfoam cushions</p>						

Note: COM/COL is not available on Brabo sling and arm. Sling and arm are ONLY available in Bristol, MCL, or Tenera Leather. COM/COL requirements provided only for pricing lookup for Bristol, MCL, and Tenera leathers in the upholstery pricing section.

Specify

- Wood
- Upholstery 1 (back and seat cushion)
- Upholstery 2 (sling and arm leather, only available in Bristol, MCL, and Tenera leather)
- Base Finish
- Fire Retardancy (specify NOCAL)

	Product Number	Depth	Width	Height	Basic Price	Upholstery
Brabo • Sofa	<i>ash frame</i> SVV6A	33	74 1/2	29 1/4	\$8,795	<i>Basic/COM Price does not include fabric. Refer to the upholstery upcharge pages for fabric and COL pricing. 1 yard = 18 sq. ft.</i>
	<i>walnut frame</i> SVV6W	33	74 1/2	29 1/4	\$9,168	
	<p><i>COM/COL (Seat and Back) 6 yards, 108 sq. ft.</i> <i>COM/COL (Sling and Arm) 4.5 yards</i> <i>Wood Frame solid ash or walnut</i> <i>Metal Frame steel plated</i> <i>Seat height 15 1/8"</i> <i>Arm height 22"</i> <i>Seat HR foam, Dacron, and polyfoam cushions</i></p>					

Note: COM/COL is not available on Brabo sling and arm. Sling and arm are ONLY available in Bristol, MCL, or Tenera Leather. COM/COL requirements provided only for pricing lookup for Bristol, MCL, and Tenera leathers in the upholstery pricing section.

Specify

- Wood
- Upholstery 1 (back and seat cushion)
- Upholstery 2 (sling and arm leather, only available in Bristol, MCL, and Tenera leather)
- Base Finish
- Fire Retardancy (specify NOCAL)

	Product Number	Depth	Width	Height	Basic Price	Upholstery
Bumper	SBR4H	28.12	27.89	28.96	\$2,659	<i>Basic/COM Price does not include fabric. Refer to the upholstery upcharge pages for fabric and COL pricing. 1 yard = 18 sq. ft.</i>
	<p>COM/COL (shell) 2 1/2 yards, 45 sq. ft. COM/COL (arm cap & cushion)..... 1 3/4 yards, 31 1/2 sq. ft. Seat height 15.76" Arm height 22.80" Base cast aluminum with black glides Frame rigid molded urethane with foam inserts Seat & back HR foam over rigid insert</p> <p>Swivel base with return to center</p>					

Specify



- Wood
- Upholstery 1 (shell, inside and outside)
- Upholstery 2 (arm cap and cushion)
- Base Finish (available only in CD polished aluminum)
- Fire Retardancy (specify NOCAL)

	Product Number	Depth	Width	Height	Basic Price	Upholstery
Clamshell <i>low back, armless</i> 	<i>ash shell</i> SSJFA	26 3/4	22 1/4	28 3/4	\$3,510	<i>Basic/COM Price does not include fabric. Refer to the upholstery upcharge pages for fabric and COL pricing. 1 yard = 18 sq. ft.</i>
	<i>Flat-cut walnut shell</i> SSJFF	26 3/4	22 1/4	28 3/4	\$3,825	
<i>COM/COL..... 1 yard, 18 sq. ft.</i> <i>Seat height 17"</i> <i>Shell..... veneered molded plywood in ash or walnut</i> <i>Legs..... solid ash or walnut in same species as shell</i> <i>Seat, back..... HR foam over rigid insert</i>						

Clamshell <i>low back, with arms</i> 	<i>ash shell</i> SSJGA	26 3/4	26 3/4	28 3/4	\$3,787	<i>Basic/COM Price does not include fabric. Refer to the upholstery upcharge pages for fabric and COL pricing. 1 yard = 18 sq. ft.</i>
	<i>Flat-cut walnut shell</i> SSJGF	26 3/4	26 3/4	28 3/4	\$4,107	
<i>COM/COL..... 1 yard, 18 sq. ft.</i> <i>Seat height 17"</i> <i>Arms..... 24 1/4", solid wood in same species as shell</i> <i>Shell..... veneered molded plywood in ash or walnut</i> <i>Legs..... solid ash or walnut in same species as shell</i> <i>Seat, back..... HR foam over rigid insert</i>						



Specify

Wood
 Upholstery
 Fire Retardancy (specify NOCAL)

	Product Number	Depth	Width	Height	Basic Price	Upholstery
Crosshatch • Chair 	ash frame SES1A	30 1/4	31 1/4	28 1/2	\$3,660	<i>Basic/COM Price does not include fabric. Refer to the upholstery upcharge pages for fabric and COL pricing. 1 yard = 18 sq. ft.</i>
	walnut frame SES1W	30 1/4	31 1/4	28 1/2	\$4,350	
	COM/COL..... 1 1/2 yards, 27 sq. ft. Seat height 14 3/4" Arm height 22 1/2" Frame solid ash or walnut Cushion HR foam and Dacron					
Crosshatch • Ottoman 	ash SES3A	16	23	13 3/4	\$1,418	<i>Basic/COM Price does not include fabric. Refer to the upholstery upcharge pages for fabric and COL pricing. 1 yard = 18 sq. ft.</i>
	walnut SES3W	16	23	13 3/4	\$1,636	
	COM/COL..... 3/4 yards, 13 1/2 sq. ft. Frame solid ash or walnut Cushion HR foam and Dacron					
Crosshatch • Settee 	ash SES4A	30 1/4	62	28 1/2	\$5,306	<i>Basic/COM Price does not include fabric. Refer to the upholstery upcharge pages for fabric and COL pricing. 1 yard = 18 sq. ft.</i>
	walnut SES4W	30 1/4	62	28 1/2	\$6,112	
	COM/COL..... 4 1/2 yards, 81 sq. ft. Seat height 14 3/4" Arm height 22 1/2" Frame solid ash or walnut Cushion HR foam and Dacron					

Specify

Wood
 Upholstery
 Fire Retardancy (specify NOCAL)
 Cord (chair and settee)

	Product Number	Depth	Width	Height	Basic Price	Upholstery
	Crosshatch Outdoor Lounge Chair					
	SOS1T	30 1/4	31 1/4	28 1/2	\$2,407	<i>Basic/COM Price does not include fabric. Refer to the upholstery upcharge pages for fabric and COL pricing. 1 yard = 18 sq. ft.</i>
		<p>COM/COL.....2 1/2 yards, 45 sq. ft. Seat height 14 3/4" Arm height 22 1/2" Frame Teak Cushion HR foam and Dacron</p>				
	Crosshatch Outdoor Ottoman					
	SOS3T	16	23	13 3/4	\$1,045	<i>Basic/COM Price does not include fabric. Refer to the upholstery upcharge pages for fabric and COL pricing. 1 yard = 18 sq. ft.</i>
		<p>COM/COL.....2 yards, 36 sq. ft. Height 13 3/4" Frame Teak Cushion HR foam and Dacron</p>				
	Crosshatch Outdoor Settee					
	SOS4T	30 1/4	62	28 1/2	\$4,045	<i>Basic/COM Price does not include fabric. Refer to the upholstery upcharge pages for fabric and COL pricing. 1 yard = 18 sq. ft.</i>
		<p>COM/COL.....6 yards, 108 sq. ft. Seat height 14 3/4" Arm height 22 1/2" Frame Teak Cushion HR foam and Dacron</p>				

Contact your local Geiger Account Manager for discounting information

Warranty for Crosshatch Outdoor Furniture is 3 Years

Upholstery Options:
 Sunbrella Heritage
 ZN401 Papyrus
 ZN402 Char

Specify

Upholstery
 Cord (chair and settee) CBK
 Black Only

	Product Number	Basic Price
	SOCV1 Lounge Chair Cover	\$395
	SOCV3 Ottoman Cover	\$195
	SOCV4 Settee Cover	\$695

Crosshatch furniture cover. Made to ward off the elements year-round, these covers are constructed of tough Weathermax, a 100% solution-dyed all-weather polyester designed especially for outdoor use. They're breathable; resistant to water, mildew, abrasion and sun exposure; and easy to clean.

This sofa has a fire-retardent free foam and down topper with a solid wood base.

Specify

Full Loop



This lounge chair has upholstered inner and outer shells and solid wood arms. The frame is rigid mold urethane with foam inserts. The 4 star, fixed height swivel-return base is available in black or polished cast aluminum with black glides.

Requires 2 3/4 yards of textile, COM/ COL is currently not offered on this product. Yardage requirement is noted to manually determine pricing.

Basic/COM price does not include fabric

Arm wrap requires 1 sq ft of leather

LIST

Specification Information

Step 1.

SL3

Step 2. Wood Arms

O oak
W walnut

Step 3. Arm Wrap

W wrap

Pricing for Step 1-3

SL3O	\$3016
SL3W	\$3608
SL3O/W	\$3272
SL3W/W	\$3865

Step 4. Upholstery

See Upholstery application chart for approved textiles

Step 5. Wood Finish

For oak (O)

WHN Natural White Oak

\$0

Step 6. Arm Wrap

1NX01 - Prone Lotus
1NX02 - Prone Timbre
1NX03 - Prone Essence
1NX04 - Prone Script
1NX05 - Prone Gambit
1NX06 - Prone Obsidian
1NX07 - Prone Sail
1NX08 - Prone Airspace
1NX09 - Prone Vine
1NX10 - Prone Yarrow
1NX11 - Prone Tatami
1NX12 - Prone Burlap
1NX13 - Prone Balsa
1NX14 - Prone Shore
1NX15 - Prone Bricolage
1NX16 - Prone Meandor
1NX17 - Prone Ledge
1NX18 - Prone Sumac
1NX19 - Prone Mantra
1NX20 - Prone Java
1NX21 - Prone Lute

\$0

Step 7. Base Finish

BK black
CD polished aluminum

\$0

\$0

Step 8. Fire Retardancy

NFR no cal 133 required

\$0

	Product Number	Depth	Width	Height	Basic Price	Upholstery
	SR1ANW Club Chair arms no arm or back pillows wood base COM/COL 6.5 yds	32 1/4"	34"	29 1/2"	\$3,565	<i>Basic/COM Price does not include fabric. Refer to the upholstery upcharge pages for fabric and COL pricing. 1 yard = 18 sq. ft.</i>
	SR1APW Club Chair arms arm and back pillows wood base COM/COL 8.5 yds	32 3/4"	34"	29 1/2"	\$4,640	
	SR1NNW Club Chair armless no arm or back pillows wood base COM/COL 4 yds	32 1/4"	26"	29 1/2"	\$2,892	
	SR1NPW Club Chair armless arm and back pillows wood base COM/COL 5.5 yds	32 1/4"	26"	29 1/2"	\$3,361	
	SR1ANS Club Chair arms no arm or back pillows swivel base with return to center COM/COL 6.5 yds	32 1/4"	34"	29 1/2"	\$4,170	
	SR1APS Club Chair arms arm and back pillows swivel base with return to center COM/COL 8.5 yds	32 3/4"	34"	29 1/2"	\$5,243	
	SR1NNS Club Chair armless no arm or back pillows swivel base with return to center COM/COL 4 yds	32 1/4"	26"	29 1/2"	\$3,565	
	SR1NPS Club Chair armless arm and back pillows swivel base with return to center COM/COL 5.5 yds	32 3/4"	26"	29 1/2"	\$4,034	

This Club Chair has a fire-retardent free foam and down topper with a solid wood base or plated steel swivel base with return-to center mechanism

Specify

	Product Number	Depth	Width	Height	Basic Price	Upholstery
	SR2ANW Settee arms no arm or back pillows wood base COM/COL 10 yds	32 1/4"	59 3/4"	29 1/2"	\$5,115	<i>Basic/COM Price does not include fabric. Refer to the upholstery upcharge pages for fabric and COL pricing. 1 yard = 18 sq. ft.</i>
	SR2ALNW Settee arms arm left armless right no arm or back pillows wood base COM/COL 8.75 yds	32 1/4"	56 1/4"	29 1/2"	\$4,724	
	SR2ARNW Settee arms arm right armless left no arm or back pillows wood base COM/COL 8.75 yds	32 1/4"	56 1/4"	29 1/2"	\$4,724	
	SR2NNW Settee armless no arm or back pillows wood base COM/COL 7.5 yds	32 1/4"	52"	29 1/2"	\$4,526	
	SR2CLANW Settee corner left, arm right no arm or back pillows wood base COM/COL 10.25 yds	32 1/4"	62 1/2"	29 1/2"	\$5,640	
	SR2CRANW Settee corner right, arm left no arm or back pillows wood base COM/COL 10.25 yds	32 1/4"	62 1/2"	29 1/2"	\$5,640	
	SR2CLNNW Settee corner left, armless right no arm or back pillows wood base COM/COL 9 yds	32 1/4"	57 1/4"	29 1/2"	\$5,115	
	SR2CRNNW Settee corner right, armless left no arm or back pillows wood base COM/COL COM/COL 9 yds	32 1/4"	57 1/4"	29 1/2"	\$5,115	
	SR2APW Settee arms, arm and back pillows wood base COM/COL 13.75 yds	32 1/4"	59 3/4"	29 1/2"	\$6,427	
	SR2ALPW Settee arm left, armless right arm and back pillows wood base COM/COL 12.5 yds	32 1/4"	56 1/4"	29 1/2"	\$5,902	
SR2ARPW Settee arm right, armless left arm and back pillows wood base COM/COL 12.5 yds	32 1/4"	56 1/4"	29 1/2"	\$5,902		
SR2NPW Settee armless arm and back pillows wood base COM/COL 11.25 yds	32 1/4"	52"	29 1/2"	\$5,314		

This settee has a fire-retardant free foam and down topper with a solid wood base.

Specify

Product Number	Depth	Width	Height	Basic Price	Upholstery
SR2CLAPW Settee corner left, arm right arm and back pillows wood base COM/COL 15.25 yds	32 1/4"	62 1/2"	29 1/2"	\$6,951	
SR2CRAPW Settee corner right, arm left arm and back pillows wood base COM/COL 15.25 yds	32 1/4"	62 1/2"	29 1/2"	\$6,951	
SR2CLNPW Settee corner left armless right arm and back pillows wood base COM/COL 14 yds	32 1/4"	57 1/2"	29 1/2"	\$6,427	
SR2CRNPW Settee corner right, armless left arm and back pillows wood baase COM/COL 14 yds	32 1/4"	57 1/2"	29 1/2"	\$6,427	

Specify

	Product Number	Depth	Width	Height	Basic Price	Upholstery
	SR3ANW Sofa arms no arm or back pillows wood base COM/COL 13.75 yds	32 1/4"	85 1/4"	29 1/2"	\$6,690	<i>Basic/COM Price does not include fabric. Refer to the upholstery upcharge pages for fabric and COL pricing. 1 yard = 18 sq. ft.</i>
	SR3ALNW Sofa arms arm left armless right no arm or back pillows wood base COM/COL 12.5 yds	32 1/4"	81 1/4"	29 1/2"	\$6,362	
	SR3ARNW Sofa arms arm right armless left no arm or back pillows wood base COM/COL 12.5 yds	32 1/4"	81 1/4"	29 1/2"	\$6,362	
	SR3NNW Sofa armless no arm or back pillows wood base COM/COL 11 yds	32 1/4"	78"	29 1/2"	\$5,969	
	SR3CLANW Sofa corner left, arm right no arm or back pillows wood base COM/COL 13.5 yds	32 1/4"	88 3/4"	29 1/2"	\$6,654	
	SR3CRANW Sofa corner right, arm left no arm or back pillows wood base COM/COL 13.5 yds	32 1/4"	88 3/4"	29 1/2"	\$6,821	
	SR3CLNNW Sofa corner left, armless right no arm or back pillows wood base COM/COL 12.25 yds	32 1/4"	84 1/2"	29 1/2"	\$6,821	
	SR3CRNNW Sofa corner right, armless left no arm or back pillows wood base COM/COL 12.25 yds	32 1/4"	84 1/2"	29 1/2"	\$6,166	
	SR3APW Sofa arms, arm and back pillows wood base COM/COL 19.25 yds	32 1/4"	85 1/4"	29 1/2"	\$8,393	
	SR3ALPW Sofa arm left, armless right arm and back pillows wood base COM/COL 18 yds	32 1/4"	81 1/4"	29 1/2"	\$7,804	
	SR3ARPW Sofa arm right, armless left arm and back pillows wood base COM/COL 18 yds	32 1/4"	81 1/4"	29 1/2"	\$7,804	
	SR3NPW Sofa armless arm and back pillows wood base COM/COL 16.5 yds	32 1/4"	78"	29 1/2"	\$7,213	

Specify

Product Number	Depth	Width	Height	Basic Price	Upholstery
SR3CLAPW Sofa corner left, arm right arm and back pillows wood base COM/COL 20.5 yds	32 1/4"	88 3/4"	29 1/2"	\$8,524	
SR3CRAPW Sofa corner right, arm left arm and back pillows wood base COM/COL 20.5 yds	32 1/4"	88 3/4"	29 1/2"	\$8,524	
SR3CLNPW Sofa corner left armless right arm and back pillows wood base COM/COL 19.25 yds	32 1/4"	84 1/2"	29 1/2"	\$7,869	
SR3CRNPW Sofa corner right, armless left arm and back pillows wood base COM/COL 19.25 yds	32 1/4"	84 1/2"	29 1/2"	\$7,869	

This sofa has a fire-retardent free foam and down topper with a solid wood base.

Specify

	Product Number	Depth	Width	Height	Basic Price	Upholstery
	SR40W Ottoman COM/COL 3 yds	26"	26"	16 3/4"	\$1,878	<i>Basic/COM Price does not include fabric. Refer to the upholstery upcharge pages for fabric and COL pricing. 1 yard = 18</i>
	SR41W Sofa Ottoman COM/COL 3.25 yds	28"	39"	16 3/4"	\$2,135	
	SR42W Two seat bench COM/COL 4.75 yds	28"	52"	16 3/4"	\$2,861	
	SR43W Three seat bench COM/COL 6.75 yds	28"	78"	16 3/4"	\$3,929	
	SR4LW 30 degree open angle bench COM/COL 4 yds	28"	49 3/4"	16 3/4"	\$2,231	
	SR4RW 30 degree closed angle bench COM/COL 4 yds	28"	49 3/4"	16 3/4"	\$2,231	
	SR5 Ganging Plate				\$104	

This ottoman and bench has a fire-retardent free foam and down topper with a solid wood base.

Specify

	Product Number	Depth	Width	Height	Basic Price	Upholstery
--	----------------	-------	-------	--------	-------------	------------

Rapport • Corner Unit	SK1	35 1/2	35 1/2	26 3/4	\$4,192	<i>Basic/COM Price does not include fabric. Refer to the upholstery upcharge pages for fabric and COL pricing. 1 yard = 18 sq. ft.</i>
------------------------------	------------	--------	--------	--------	---------	--

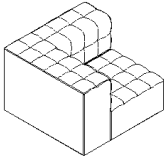

COM/COL..... 5 yards, 90 sq. ft.
 Seat height 15"
 Arm height 26 3/4"
 Base solid ash or walnut
 Cushion foam and Dacron

Specify

Upholstery
 Base Finish
 Fire Retardancy (specify NOCAL)

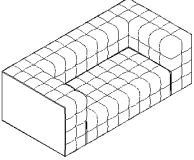
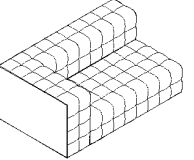
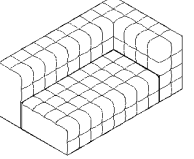
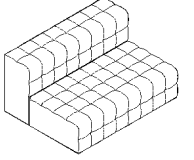
	Product Number	Depth	Width	Height	Basic Price	Upholstery
Rapport • Settee with arms 	SK2A	35 3/8	70 7/8	26 3/4	\$6,880	<i>Basic/COM Price does not include fabric. Refer to the upholstery upcharge pages for fabric and COL pricing. 1 yard = 18 sq. ft.</i>
		COM/COL..... 9 1/2 yards, 171 sq. ft. Seat height 15" Arm height 26 3/4" Base solid ash or walnut Cushion foam and Dacron				
Rapport • Settee arm right, connection left 	SK2CL	35 3/8	59	26 3/4	\$6,815	<i>Basic/COM Price does not include fabric. Refer to the upholstery upcharge pages for fabric and COL pricing. 1 yard = 18 sq. ft.</i>
		COM/COL..... 7 1/2 yards, 135 sq. ft. Seat height 15" Arm height 26 3/4" Base solid ash or walnut Cushion foam and Dacron				
Rapport • Settee arm left, connection right 	SK2CR	35 3/8	59	26 3/4	\$6,815	<i>Basic/COM Price does not include fabric. Refer to the upholstery upcharge pages for fabric and COL pricing. 1 yard = 18 sq. ft.</i>
		COM/COL..... 7 1/2 yards, 135 sq. ft. Seat height 15" Arm height 26 3/4" Base solid ash or walnut Cushion foam and Dacron				
Rapport • Settee armless 	SK2N	35 3/8	47 1/4	26 3/4	\$6,026	<i>Basic/COM Price does not include fabric. Refer to the upholstery upcharge pages for fabric and COL pricing. 1 yard = 18 sq. ft.</i>
		COM/COL..... 5 1/4 yards, 94 1/2 sq. ft. Seat height 15" Base solid ash or walnut Cushion foam and Dacron				

Specify

Upholstery
 Base Finish
 Fire Retardancy (specify NOCAL)

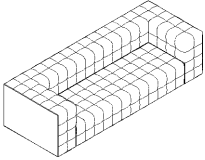
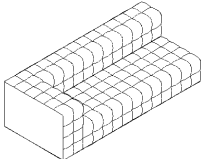
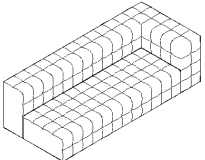
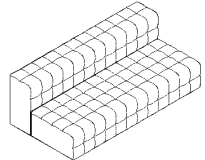
	Product Number	Depth	Width	Height	Basic Price	Upholstery
Rapport • Sofa with arms 	SK3A	35 3/8	94 1/2	26 3/4	\$7,993	Basic/COM Price does not include fabric. Refer to the upholstery upcharge pages for fabric and COL pricing. 1 yard = 18 sq. ft.
		COM/COL..... 10 3/4 yards, 193 1/2 sq. ft. Seat height 15" Arm height 26 3/4" Base solid ash or walnut Cushion foam and Dacron				
Rapport • Sofa arm right, connection left 	SK3CL	35 3/8	82 5/8	26 3/4	\$7,930	Basic/COM Price does not include fabric. Refer to the upholstery upcharge pages for fabric and COL pricing. 1 yard = 18 sq. ft.
		COM/COL..... 8 3/4 yards, 157 1/2 sq. ft. Seat height 15" Arm height 26 3/4" Base solid ash or walnut Cushion foam and Dacron				
Rapport • Sofa arm left, connection right 	SK3CR	35 3/8	82 5/8	26 3/4	\$7,930	Basic/COM Price does not include fabric. Refer to the upholstery upcharge pages for fabric and COL pricing. 1 yard = 18 sq. ft.
		COM/COL..... 8 3/4 yards, 157 1/2 sq. ft. Seat height 15" Arm height 26 3/4" Base solid ash or walnut Cushion foam and Dacron				
Rapport • Sofa armless 	SK3N	35 3/8	70 7/8	26 3/4	\$7,143	Basic/COM Price does not include fabric. Refer to the upholstery upcharge pages for fabric and COL pricing. 1 yard = 18 sq. ft.
		COM/COL..... 7 1/4 yards, 130 1/2 sq. ft. Seat height 15" Base solid ash or walnut Cushion foam and Dacron				

Specify

Upholstery
Base Finish
Fire Retardancy (specify NOCAL)

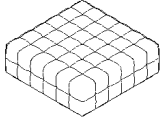
	Product Number	Depth	Width	Height	Basic Price	Upholstery
Rapport • Ottoman <i>small</i> 	SK4A	35 1/2	35 1/2	15	\$3,143	<i>Basic/COM Price does not include fabric. Refer to the upholstery upcharge pages for fabric and COL pricing. 1 yard = 18 sq. ft.</i>
		<i>COM/COL..... 2 3/4 yards, 49 1/2 sq. ft.</i> <i>Base solid ash or walnut</i> <i>Cushion foam and Dacron</i>				

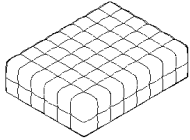
Rapport • Ottoman <i>large</i> 	SK4B	35 1/2	47 1/4	15	\$3,405	<i>Basic/COM Price does not include fabric. Refer to the upholstery upcharge pages for fabric and COL pricing. 1 yard = 18 sq. ft.</i>
		<i>COM/COL..... 3 3/4 yards, 67 1/2 sq. ft.</i> <i>Base solid ash or walnut</i> <i>Cushion foam and Dacron</i>				

Specify

Upholstery
 Base Finish
 Fire Retardancy (specify NOCAL)

	Product Number	Depth	Width	Height	Basic Price	Upholstery
Rapport • Pillow small	SK6	4	18	18	\$238	<i>Basic Price does not include fabric. Add textile upcharge listed below.</i>



COM/COL..... 1 yard, 18 sq. ft.

Price Group	Fabric Upcharge Per Pillow
1	+\$49
2	+\$59
3	+\$73
4	+\$90
5	+\$131
6	+\$173
7	+\$212
8	+\$324
9	+\$402
10	+\$463
11	+\$518
12	+\$592
13	+\$612
14	+\$679
A	+\$41
B	+\$47
C	+\$66
D	+\$88
E	+\$106
F	+\$127

Price Group	Fabric Upcharge Per Pillow
G	+\$173
H	+\$215
I	+\$259
J	+\$304
K	+\$348
L	+\$392
M	+\$437
N	+\$481
O	+\$526
P	+\$569
Q	+\$656
R	+\$916
S	+\$983
T	+\$1051
U	+\$1120
V	+\$1187
W	+\$1,255
X	+\$1,324
Y	+\$1,391
Z	+\$1,459

Specify

Upholstery*

**Available only in limited fabrics. Not available in COM/COL.
Pillows are filled with 95% duck down feathers.
Depth is approximate based on how much the pillow is fluffed.*

	Product Number	Depth	Width	Height	Basic Price	Upholstery
Rapport • Pillow large	SK5	4	21	31	\$331	<i>Basic Price does not include fabric. Add textile upcharge listed below.</i>



COM/COL..... 1 1/2 yards, 27 sq. ft.



Price Group	Fabric Upcharge Per Pillow
1	+\$62
2	+\$74
3	+\$92
4	+\$113
5	+\$164
6	+\$215
7	+\$266
8	+\$405
9	+\$503
10	+\$579
11	+\$648
12	+\$740
13	+\$765
14	+\$849
A	+\$51
B	+\$59
C	+\$83
D	+\$110
E	+\$132
F	+\$159

Price Group	Fabric Upcharge Per Pillow
G	+\$216
H	+\$269
I	+\$324
J	+\$380
K	+\$435
L	+\$491
M	+\$546
N	+\$602
O	+\$657
P	+\$711
Q	+\$821
R	+\$1,145
S	+\$1,229
T	+\$1,314
U	+\$1,400
V	+\$1,484
W	+\$1,569
X	+\$1,655
Y	+\$1,739
Z	+\$1,824

Specify

Upholstery*

**Available only in limited fabrics. Not available in COM/COL.
Pillows are filled with 95% duck down feathers.
Depth is approximate based on how much the pillow is fluffed.*

	Product Number	Depth	Width	Height	Basic Price	Upholstery
Reframe Mid-Back 	ash frame SJAA	32 1/8"	31 1/4"	30 3/8"	\$3,524	<i>Basic/COM Price does not include fabric. Refer to the upholstery upcharge pages for fabric and COL pricing. 1 yard = 18 sq. ft.</i>
	walnut frame SJAW	32 1/8"	31 1/4"	30 3/8"	\$4,181	
	COM/COL..... 3 1/2 yards, 63 sq. ft. Seat Height..... 16 5/8" Inside Arm Width 23" Seat rigid and soft polyurethane foam Frame solid ash or walnut					
Reframe High-Back 	ash frame SJBA	33 3/8"	31 1/4"	38 3/4"	\$3,723	<i>Basic/COM Price does not include fabric. Refer to the upholstery upcharge pages for fabric and COL pricing. 1 yard = 18 sq. ft.</i>
	walnut frame SJBW	33 3/8"	31 1/4"	38 3/4"	\$4,380	
	COM/COL..... 3 3/4 yards, 67.5 sq. ft. Seat Height..... 16 5/8" Inside Arm Width 23" Seat rigid and soft polyurethane foam Frame solid ash or walnut					
Reframe Wing-Back 	ash frame SJCA	33 1/2"	31 1/4"	45 1/4"	\$3,988	<i>Basic/COM Price does not include fabric. Refer to the upholstery upcharge pages for fabric and COL pricing. 1 yard = 18 sq. ft.</i>
	walnut frame SJCW	33 1/2"	31 1/4"	45 1/4"	\$4,647	
	COM/COL..... 4 1/4 yards, 76.5 sq. ft. Seat Height..... 16 5/8" Inside Arm Width 23" Seat rigid and soft polyurethane foam Frame solid ash or walnut					

Specify

Wood Finish
 Upholstery
 Fire Retardancy (specify NOCAL)

	Product Number	Depth	Width	Height	Basic Price	Upholstery
--	----------------	-------	-------	--------	-------------	------------

Rolled Arm Chair	SBRA-43	32 1/2	43	24 3/4	\$4,664	<i>Basic/COM Price does not include fabric. Refer to the upholstery upcharge pages for fabric and COL pricing. 1 yard = 18 sq. ft.</i>
-------------------------	----------------	--------	----	--------	---------	--



COM/COL..... 6 yards, 108 sq. ft.
 Seat height 16"
 Arm Height..... 24 3/4"
 Seat, back..... plywood with HR foam and Dacron
 Arms HR foam, Dacron, and polyfoam
 Legs..... solid wood in select walnut or ash finishes

Rolled Arm Sofa	SBRA-72	32 1/2	72	24 3/4	\$6,540	<i>Basic/COM Price does not include fabric. Refer to the upholstery upcharge pages for fabric and COL pricing. 1 yard = 18 sq. ft.</i>
------------------------	----------------	--------	----	--------	---------	--



COM/COL..... 9 yards, 162 sq. ft.
 Seat height 16"
 Arm Height..... 24 3/4"
 Seat, back..... plywood with HR foam and Dacron
 Arms HR foam, Dacron, and polyfoam
 Legs..... solid wood in select walnut or ash finishes

	SBRA-84	32 1/2	84	24 3/4	\$6,841	<i>Basic/COM Price does not include fabric. Refer to the upholstery upcharge pages for fabric and COL pricing. 1 yard = 18 sq. ft.</i>
--	----------------	--------	----	--------	---------	--

COM/COL..... 11 yards, 198 sq. ft.
 Seat height 16"
 Arm Height..... 24 3/4"
 Seat, back..... plywood with HR foam and Dacron
 Arms HR foam, Dacron, and polyfoam
 Legs..... solid wood in select walnut or ash finishes

	SBRA-96	32 1/2	96	24 3/4	\$7,385	<i>Basic/COM Price does not include fabric. Refer to the upholstery upcharge pages for fabric and COL pricing. 1 yard = 18 sq. ft.</i>
--	----------------	--------	----	--------	---------	--

COM/COL..... 12 1/2 yards, 225 sq. ft.
 Seat height 16"
 Arm Height..... 24 3/4"
 Seat, back..... plywood with HR foam and Dacron
 Arms HR foam, Dacron, and polyfoam
 Legs..... solid wood in select walnut or ash finishes

Specify

Wood (legs)
 Upholstery
 Fire Retardancy (specify NOCAL)

	Product Number	Depth	Width	Height	Basic Price	Upholstery
Saiba lounge, high-back 	SBN5H	32	30 1/2	32 1/2	\$3,668	<i>Basic/COM Price does not include fabric. Refer to the upholstery upcharge pages for fabric and COL pricing. 1 yard = 18 sq. ft.</i>
	<i>Fabric Req. 3 1/2 yards, 63 sq. ft.</i> <i>Shell.....rigid urethane with polyurethane foam</i> <i>Base4-star die cast aluminum with black glides, swivels</i> <i>Seat height 16 1/4"</i> <i>Seat depth 19 1/4"</i> <i>Arm height 19 3/4"</i> <i>Cushionhigh density HR foam</i>					

Specify

Upholstery (not available in Bristol leather 5-597 Pure)
 Base Finish
 Fire Retardancy (specify NOCAL)

Note: Saiba lounge chair requires an additional 3.5 yards of fabric / 63 sq. ft. of leather for testing for all COM/COL orders, plus the standard memo-sized sample.

	Product Number	Depth	Width	Height	Basic Price	Upholstery
Saiba ottoman 	SBN6	19 1/4	25 1/4	17 1/2	\$1,464	<i>Basic Price does not include fabric. Refer to the upholstery upcharge pages for fabric pricing. 1 yard = 18 sq. ft.</i> <i>Not available with COM or COL</i>
	<i>Fabric Req. 1 yard, 18 sq. ft.</i> <i>Base 4-star die cast aluminum with black glides</i> <i>Cushion high density HR foam</i>					

Specify

Upholstery (not available in Bristol leather 5-597 Pure)
 Base Finish
 Fire Retardancy (specify NOCAL)

Note: Saiba lounge ottoman requires an additional 1 yard of fabric / 18 sq. ft. of leather for testing for all COM/COL orders, plus the standard memo-sized sample.

	Product Number	Depth	Width	Height	Basic Price	Upholstery
Scissor wood or metal frame 	<i>ash frame</i> SBSC-1098	30	24	33	\$4,006	<i>Basic/COM Price does not include fabric. Refer to the upholstery upcharge pages for fabric and COL pricing. 1 yard = 18 sq. ft.</i>
	<i>metal frame</i> SBSD-1099	29	24	33	\$4,100	
<i>COM/COL..... 3 1/2 yards, 63 sq. ft.</i> <i>Seat height 15 1/2"</i> <i>Frame solid ash or welded tubular steel</i> <i>Seat foam and Dacron over plywood</i> <i>Back HR foam over hardwood insert</i>						





Specify

Upholstery
Wood (Not required on Scissor chair with metal frame)
Base (Not required on Scissor chair with wood frame)
Fire Retardancy (specify NOCAL)

	Product Number	Depth	Width	Height	Basic Price	Upholstery
Sled metal frame 	SBSU-1060	30 1/2	28 1/2	31	\$6,144	<i>Basic/COM Price does not include fabric. Refer to the upholstery upcharge pages for fabric and COL pricing. 1 yard = 18 sq. ft.</i>
	COM/COL..... 3 yards, 54 sq. ft. Seat height 17" Frame welded tubular steel Seat foam and Dacron over plywood Back HR foam over hardwood insert					

Specify

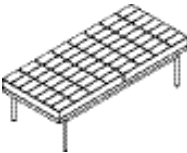
Upholstery
 Base Finish
 Fire Retardancy (specify NOCAL)

	Product Number	Depth	Width	Height	Basic Price	Upholstery
Tuxedo • Ottoman <i>quilted</i> 	ST1BQ	28	28	17	\$1,786	<i>Basic/COM Price does not include fabric. Refer to the upholstery upcharge pages for fabric and COL pricing. 1 yard = 18 sq. ft.</i>
	<i>COM/COL..... 1 1/2 yards, 27 sq. ft.</i> <i>Seat height 17"</i> <i>Seat..... foam and Dacron</i> <i>Base painted or plated steel</i>					
Tuxedo • Ottoman <i>non-quilted</i> 	ST1BN	28	28	17	\$1,740	<i>Basic/COM Price does not include fabric. Refer to the upholstery upcharge pages for fabric and COL pricing. 1 yard = 18 sq. ft.</i>
	<i>COM/COL..... 1 1/2 yards, 27 sq. ft.</i> <i>Seat height 17"</i> <i>Seat..... foam and Dacron</i> <i>Base painted or plated steel</i>					
Tuxedo • Bench <i>quilted</i> 	ST2BQ	28	56	17	\$2,939	<i>Basic/COM Price does not include fabric. Refer to the upholstery upcharge pages for fabric and COL pricing. 1 yard = 18 sq. ft.</i>
	<i>specify ganging plates (STGP) separately</i> <i>COM/COL..... 3 yards, 54 sq. ft.</i> <i>Seat height 17"</i> <i>Seat..... foam and Dacron</i> <i>Base painted or plated steel</i>					
Tuxedo • Bench <i>non-quilted</i> 	ST2BN	28	56	17	\$2,849	<i>Basic/COM Price does not include fabric. Refer to the upholstery upcharge pages for fabric and COL pricing. 1 yard = 18 sq. ft.</i>
	<i>specify ganging plates (STGP) separately</i> <i>COM/COL..... 3 yards, 54 sq. ft.</i> <i>Seat height 17"</i> <i>Seat..... foam and Dacron</i> <i>Base painted or plated steel</i>					

Specify

Upholstery
 Base Finish
 Fire Retardancy (specify NOCAL)

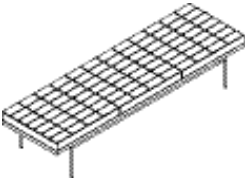
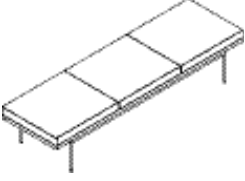
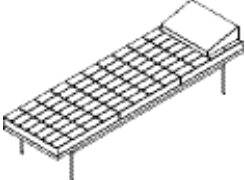
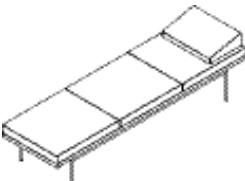

Note: Tuxedo Component Ottomans cannot be ganged to other seating.

	Product Number	Depth	Width	Height	Basic Price	Upholstery
Tuxedo • Bench <i>quilted</i> 	ST3BQ specify ganging plates (STGP) separately COM/COL..... 5 1/2 yards, 99 sq. ft. Seat height 17" Seat foam and Dacron Base painted or plated steel	28	84	17	\$3,988	Basic/COM Price does not include fabric. Refer to the upholstery upcharge pages for fabric and COL pricing. 1 yard = 18 sq. ft.
Tuxedo • Bench <i>non-quilted</i> 	ST3BN specify ganging plates (STGP) separately COM/COL..... 5 1/2 yards, 99 sq. ft. Seat height 17" Seat foam and Dacron Base painted or plated steel	28	84	17	\$3,903	Basic/COM Price does not include fabric. Refer to the upholstery upcharge pages for fabric and COL pricing. 1 yard = 18 sq. ft.
Tuxedo • Daybed <i>quilted</i> 	ST3DQ COM/COL..... 6 1/2 yards, 117 sq. ft. Seat height 17" Seat foam and Dacron Base painted or plated steel	28	84	22 1/4	\$4,454	Basic/COM Price does not include fabric. Refer to the upholstery upcharge pages for fabric and COL pricing. 1 yard = 18 sq. ft.
Tuxedo • Daybed <i>non-quilted</i> 	ST3DN COM/COL..... 6 1/2 yards, 117 sq. ft. Seat height 17" Seat foam and Dacron Base painted or plated steel	28	84	22 1/4	\$4,363	Basic/COM Price does not include fabric. Refer to the upholstery upcharge pages for fabric and COL pricing. 1 yard = 18 sq. ft.

Specify

Upholstery
 Base Finish
 Fire Retardancy (specify NOCAL)

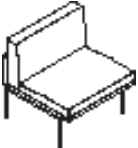

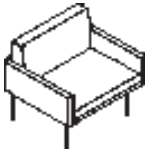
Note: Tuxedo Component Daybeds cannot be ganged to other seating.

	Product Number	Depth	Width	Height	Basic Price	Upholstery
Tuxedo • Club Chair <i>armless, quilted</i> 	ST1NQ	28	28	30	\$3,601	<i>Basic/COM Price does not include fabric. Refer to the upholstery upcharge pages for fabric and COL pricing. 1 yard = 18 sq. ft.</i>
	<i>COM/COL..... 3 3/4 yards, 67 1/2 sq. ft.</i> <i>Seat height 17"</i> <i>Seat foam and Dacron</i> <i>Base painted or plated steel</i>					
Tuxedo • Club Chair <i>armless, non-quilted</i> 	ST1NN	28	28	30	\$3,353	<i>Basic/COM Price does not include fabric. Refer to the upholstery upcharge pages for fabric and COL pricing. 1 yard = 18 sq. ft.</i>
	<i>COM/COL..... 3 3/4 yards, 67 1/2 sq. ft.</i> <i>Seat height 17"</i> <i>Seat foam and Dacron</i> <i>Base painted or plated steel</i>					
Tuxedo • Club Chair <i>with arms, quilted</i> 	ST1AQ	28	32	30	\$4,409	<i>Basic/COM Price does not include fabric. Refer to the upholstery upcharge pages for fabric and COL pricing. 1 yard = 18 sq. ft.</i>
	<i>COM/COL..... 5 1/2 yards, 99 sq. ft.</i> <i>Seat height 17"</i> <i>Arm height 23 1/2"</i> <i>Seat foam and Dacron</i> <i>Base painted or plated steel</i>					
Tuxedo • Club Chair <i>with arms, non-quilted</i> 	ST1AN	28	32	30	\$4,245	<i>Basic/COM Price does not include fabric. Refer to the upholstery upcharge pages for fabric and COL pricing. 1 yard = 18 sq. ft.</i>
	<i>COM/COL..... 5 1/2 yards, 99 sq. ft.</i> <i>Seat height 17"</i> <i>Arm height 23 1/2"</i> <i>Seat foam and Dacron</i> <i>Base painted or plated steel</i>					

Specify

Upholstery
 Base Finish
 Fire Retardancy (specify NOCAL)

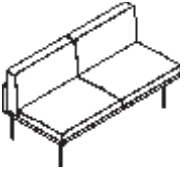

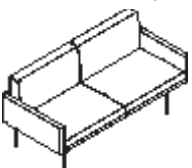
Note: Tuxedo Component Club Chairs cannot be ganged to other seating.

	Product Number	Depth	Width	Height	Basic Price	Upholstery
Tuxedo • Settee armless, quilted 	ST2NQ specify ganging plates (STGP) separately COM/COL..... 7 1/2 yards, 135 sq. ft. Seat height 17" Arm height 23 1/2" Seat foam and Dacron Base painted or plated steel	28	56	30	\$5,229	Basic/COM Price does not include fabric. Refer to the upholstery upcharge pages for fabric and COL pricing. 1 yard = 18 sq. ft.
Tuxedo • Settee armless, non-quilted 	ST2NN specify ganging plates (STGP) separately COM/COL..... 7 1/2 yards, 135 sq. ft. Seat height 17" Arm height 23 1/2" Seat foam and Dacron Base painted or plated steel	28	56	30	\$5,083	Basic/COM Price does not include fabric. Refer to the upholstery upcharge pages for fabric and COL pricing. 1 yard = 18 sq. ft.
Tuxedo • Settee with arms, quilted 	ST2AQ COM/COL..... 9 1/4 yards, 166 1/2 sq. ft. Seat height 17" Arm height 23 1/2" Seat foam and Dacron Base painted or plated steel	28	60	30	\$6,178	Basic/COM Price does not include fabric. Refer to the upholstery upcharge pages for fabric and COL pricing. 1 yard = 18 sq. ft.
Tuxedo • Settee with arms, non-quilted 	ST2AN COM/COL..... 9 1/4 yards, 166 1/2 sq. ft. Seat height 17" Arm height 23 1/2" Seat foam and Dacron Base painted or plated steel	28	60	30	\$5,786	Basic/COM Price does not include fabric. Refer to the upholstery upcharge pages for fabric and COL pricing. 1 yard = 18 sq. ft.

Specify

Upholstery
 Base Finish
 Fire Retardancy (specify NOCAL)

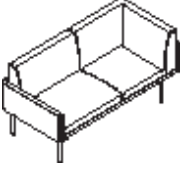

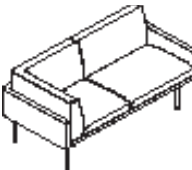
Note: Tuxedo Component Settees ST2AN and ST2AQ cannot be ganged to other seating.

	Product Number	Depth	Width	Height	Basic Price	Upholstery
Tuxedo • Settee corner left, arm right, quilted 	ST2CLAQ includes one set of two ganging plates COM/COL..... 10 1/4 yards, 184 1/2 sq. ft. Seat height 17" Arm height 23 1/2" Seat foam and Dacron Base painted or plated steel	28	58	30	\$6,671	Basic/COM Price does not include fabric. Refer to the upholstery upcharge pages for fabric and COL pricing. 1 yard = 18 sq. ft.
Tuxedo • Settee corner left, arm right, non-quilted 	ST2CLAN includes one set of two ganging plates COM/COL..... 10 1/4 yards, 184 1/2 sq. ft. Seat height 17" Arm height 23 1/2" Seat foam and Dacron Base painted or plated steel	28	58	30	\$6,388	Basic/COM Price does not include fabric. Refer to the upholstery upcharge pages for fabric and COL pricing. 1 yard = 18 sq. ft.
Tuxedo • Settee corner right, arm left, quilted 	ST2CRAQ includes one set of two ganging plates COM/COL..... 10 1/4 yards, 184 1/2 sq. ft. Seat height 17" Arm height 23 1/2" Seat foam and Dacron Base painted or plated steel	28	58	30	\$6,671	Basic/COM Price does not include fabric. Refer to the upholstery upcharge pages for fabric and COL pricing. 1 yard = 18 sq. ft.
Tuxedo • Settee corner right, arm left, non-quilted 	ST2CRAN includes one set of two ganging plates COM/COL..... 10 1/4 yards, 184 1/2 sq. ft. Seat height 17" Arm height 23 1/2" Seat foam and Dacron Base painted or plated steel	28	58	30	\$6,388	Basic/COM Price does not include fabric. Refer to the upholstery upcharge pages for fabric and COL pricing. 1 yard = 18 sq. ft.

Specify

Upholstery
 Base Finish
 Fire Retardancy (specify NOCAL)

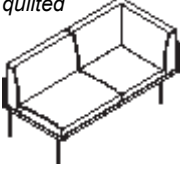

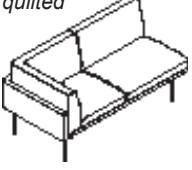
See Geiger occasional tables pricebook for Tuxedo component occasional tables.

	Product Number	Depth	Width	Height	Basic Price	Upholstery
<p>Tuxedo • Settee corner left, armless right, quilted</p> 	<p>ST2CLNQ includes one set of two ganging plates</p>	28	56	30	\$6,238	<p><i>Basic/COM Price does not include fabric. Refer to the upholstery upcharge pages for fabric and COL pricing. 1 yard = 18 sq. ft.</i></p>
	<p>COM/COL..... 9 1/4 yards, 166 1/2 sq. ft. Seat height 17" Arm height 23 1/2" Seat foam and Dacron Base painted or plated steel</p>					
<p>Tuxedo • Settee corner left, armless right, non-quilted</p> 	<p>ST2CLNN includes one set of two ganging plates</p>	28	56	30	\$6,127	<p><i>Basic/COM Price does not include fabric. Refer to the upholstery upcharge pages for fabric and COL pricing. 1 yard = 18 sq. ft.</i></p>
	<p>COM/COL..... 9 1/4 yards, 166 1/2 sq. ft. Seat height 17" Arm height 23 1/2" Seat foam and Dacron Base painted or plated steel</p>					
<p>Tuxedo • Settee corner right, armless left, quilted</p> 	<p>ST2CRNQ includes one set of two ganging plates</p>	28	56	30	\$6,238	<p><i>Basic/COM Price does not include fabric. Refer to the upholstery upcharge pages for fabric and COL pricing. 1 yard = 18 sq. ft.</i></p>
	<p>COM/COL..... 9 1/4 yards, 166 1/2 sq. ft. Seat height 17" Arm height 23 1/2" Seat foam and Dacron Base painted or plated steel</p>					
<p>Tuxedo • Settee corner right, armless left, non-quilted</p> 	<p>ST2CRNN includes one set of two ganging plates</p>	28	56	30	\$6,127	<p><i>Basic/COM Price does not include fabric. Refer to the upholstery upcharge pages for fabric and COL pricing. 1 yard = 18 sq. ft.</i></p>
	<p>COM/COL..... 9 1/4 yards, 166 1/2 sq. ft. Seat height 17" Arm height 23 1/2" Seat foam and Dacron Base painted or plated steel</p>					

Specify

Upholstery
Base Finish
Fire Retardancy (specify NOCAL)

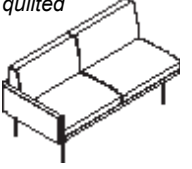
See Geiger occasional tables pricebook for Tuxedo component occasional tables.

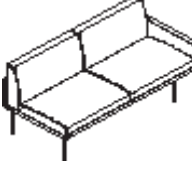
	Product Number	Depth	Width	Height	Basic Price	Upholstery
<p>Tuxedo • Settee arm right, armless left, quilted</p> 	<p>ST2ARQ specify ganging plates (STGP) separately</p> <p>COM/COL..... 8 1/2 yards, 153 sq. ft. Seat height 17" Arm height 23 1/2" Seat foam and Dacron Base painted or plated steel</p>	28	58	30	\$5,464	Basic/COM Price does not include fabric. Refer to the upholstery upcharge pages for fabric and COL pricing. 1 yard = 18 sq. ft.
<p>Tuxedo • Settee arm right, armless left, non-quilted</p> 	<p>ST2ARN specify ganging plates (STGP) separately</p> <p>COM/COL..... 8 1/2 yards, 153 sq. ft. Seat height 17" Arm height 23 1/2" Seat foam and Dacron Base painted or plated steel</p>	28	58	30	\$5,287	Basic/COM Price does not include fabric. Refer to the upholstery upcharge pages for fabric and COL pricing. 1 yard = 18 sq. ft.
<p>Tuxedo • Settee arm left, armless right, quilted</p> 	<p>ST2ALQ specify ganging plates (STGP) separately</p> <p>COM/COL..... 8 1/2 yards, 153 sq. ft. Seat height 17" Arm height 23 1/2" Seat foam and Dacron Base painted or plated steel</p>	28	58	30	\$5,464	Basic/COM Price does not include fabric. Refer to the upholstery upcharge pages for fabric and COL pricing. 1 yard = 18 sq. ft.
<p>Tuxedo • Settee arm left, armless right, non-quilted</p> 	<p>ST2ALN specify ganging plates (STGP) separately</p> <p>COM/COL..... 8 1/2 yards, 153 sq. ft. Seat height 17" Arm height 23 1/2" Seat foam and Dacron Base painted or plated steel</p>	28	58	30	\$5,287	Basic/COM Price does not include fabric. Refer to the upholstery upcharge pages for fabric and COL pricing. 1 yard = 18 sq. ft.

Specify

Upholstery
Base Finish
Fire Retardancy (specify NOCAL)

See Geiger occasional tables pricebook for Tuxedo component occasional tables.

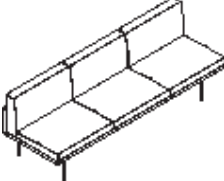
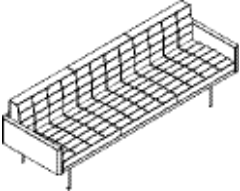
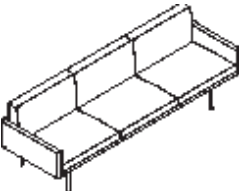

	Product Number	Depth	Width	Height	Basic Price	Upholstery
<p>Tuxedo • Sofa armless, quilted</p> 	<p>ST3NQ specify ganging plates (STGP) separately</p> <p>COM/COL..... 11 1/4 yards, 202 1/2 sq. ft. Seat height 17" Seat foam and Dacron Base painted or plated steel</p>	28	84	30	\$7,266	Basic/COM Price does not include fabric. Refer to the upholstery upcharge pages for fabric and COL pricing. 1 yard = 18 sq. ft.
<p>Tuxedo • Sofa armless, non-quilted</p> 	<p>ST3NN specify ganging plates (STGP) separately</p> <p>COM/COL..... 11 1/4 yards, 202 1/2 sq. ft. Seat height 17" Seat foam and Dacron Base painted or plated steel</p>	28	84	30	\$7,024	Basic/COM Price does not include fabric. Refer to the upholstery upcharge pages for fabric and COL pricing. 1 yard = 18 sq. ft.
<p>Tuxedo • Sofa with arms, quilted</p> 	<p>ST3AQ</p> <p>COM/COL..... 13 yards, 234 sq. ft. Seat height 17" Arm height 23 1/2" Seat foam and Dacron Base painted or plated steel</p>	28	88	30	\$8,139	Basic/COM Price does not include fabric. Refer to the upholstery upcharge pages for fabric and COL pricing. 1 yard = 18 sq. ft.
<p>Tuxedo • Sofa with arms, non-quilted</p> 	<p>ST3AN</p> <p>COM/COL..... 13 yards, 234 sq. ft. Seat height 17" Arm height 23 1/2" Seat foam and Dacron Base painted or plated steel</p>	28	88	30	\$7,896	Basic/COM Price does not include fabric. Refer to the upholstery upcharge pages for fabric and COL pricing. 1 yard = 18 sq. ft.

Specify

Upholstery
Base Finish
Fire Retardancy (specify NOCAL)

See Geiger occasional tables pricebook for Tuxedo component occasional tables.

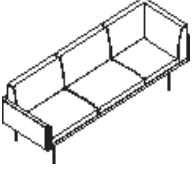

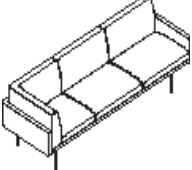
Note: Tuxedo Component Sofas ST3AN and ST3AQ cannot be ganged to other seating.

	Product Number	Depth	Width	Height	Basic Price	Upholstery
Tuxedo • Sofa corner left, arm right, quilted 	ST3CLAQ includes one set of two ganging plates COM/COL..... 14 yards, 252 sq. ft. Seat height 17" Arm height 23 1/2" Seat foam and Dacron Base painted or plated steel	28	86	30	\$8,638	Basic/COM Price does not include fabric. Refer to the upholstery upcharge pages for fabric and COL pricing. 1 yard = 18 sq. ft.
Tuxedo • Sofa corner left, arm right, non-quilted 	ST3CLAN includes one set of two ganging plates COM/COL..... 14 yards, 252 sq. ft. Seat height 17" Arm height 23 1/2" Seat foam and Dacron Base painted or plated steel	28	86	30	\$8,402	Basic/COM Price does not include fabric. Refer to the upholstery upcharge pages for fabric and COL pricing. 1 yard = 18 sq. ft.
Tuxedo • Sofa corner right, arm left, quilted 	ST3CRAQ includes one set of two ganging plates COM/COL..... 14 yards, 252 sq. ft. Seat height 17" Arm height 23 1/2" Seat foam and Dacron Base painted or plated steel	28	86	30	\$8,638	Basic/COM Price does not include fabric. Refer to the upholstery upcharge pages for fabric and COL pricing. 1 yard = 18 sq. ft.
Tuxedo • Sofa corner right, arm left, non-quilted 	ST3CRAN includes one set of two ganging plates COM/COL..... 14 yards, 252 sq. ft. Seat height 17" Arm height 23 1/2" Seat foam and Dacron Base painted or plated steel	28	86	30	\$8,402	Basic/COM Price does not include fabric. Refer to the upholstery upcharge pages for fabric and COL pricing. 1 yard = 18 sq. ft.

Specify

Upholstery
 Base Finish
 Fire Retardancy (specify NOCAL)

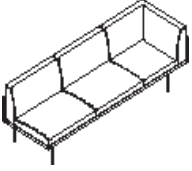

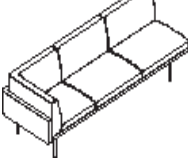
See Geiger occasional tables pricebook for Tuxedo component occasional tables.

	Product Number	Depth	Width	Height	Basic Price	Upholstery
Tuxedo • Sofa corner left, armless right, quilted 	ST3CLNQ includes one set of two ganging plates COM/COL..... 13 yards, 234 sq. ft. Seat height 17" Arm height 23 1/2" Seat foam and Dacron Base painted or plated steel	28	84	30	\$8,210	Basic/COM Price does not include fabric. Refer to the upholstery upcharge pages for fabric and COL pricing. 1 yard = 18 sq. ft.
Tuxedo • Sofa corner left, armless right, non-quilted 	ST3CLNN includes one set of two ganging plates COM/COL..... 13 yards, 234 sq. ft. Seat height 17" Arm height 23 1/2" Seat foam and Dacron Base painted or plated steel	28	84	30	\$8,113	Basic/COM Price does not include fabric. Refer to the upholstery upcharge pages for fabric and COL pricing. 1 yard = 18 sq. ft.
Tuxedo • Sofa corner right, armless left, quilted 	ST3CRNQ includes one set of two ganging plates COM/COL..... 13 yards, 234 sq. ft. Seat height 17" Arm height 23 1/2" Seat foam and Dacron Base painted or plated steel	28	84	30	\$8,210	Basic/COM Price does not include fabric. Refer to the upholstery upcharge pages for fabric and COL pricing. 1 yard = 18 sq. ft.
Tuxedo • Sofa corner right, armless left, non-quilted 	ST3CRNN includes one set of two ganging plates COM/COL..... 13 yards, 234 sq. ft. Seat height 17" Arm height 23 1/2" Seat foam and Dacron Base painted or plated steel	28	84	30	\$8,113	Basic/COM Price does not include fabric. Refer to the upholstery upcharge pages for fabric and COL pricing. 1 yard = 18 sq. ft.

Specify

Upholstery
 Base Finish
 Fire Retardancy (specify NOCAL)

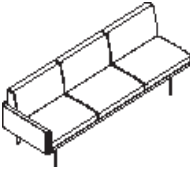
See Geiger occasional tables pricebook for Tuxedo component occasional tables.

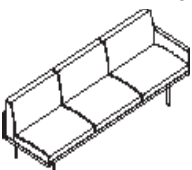
	Product Number	Depth	Width	Height	Basic Price	Upholstery
<p>Tuxedo • Sofa arm right, armless left, quilted</p> 	<p>ST3ARQ specify ganging plates (STGP) separately</p> <p>COM/COL..... 12 1/4 yards, 220 1/2 sq. ft. Seat height 17" Arm height 23 1/2" Seat foam and Dacron Base painted or plated steel</p>	28	86	30	\$7,588	Basic/COM Price does not include fabric. Refer to the upholstery upcharge pages for fabric and COL pricing. 1 yard = 18 sq. ft.
<p>Tuxedo • Sofa arm right, armless left, non-quilted</p> 	<p>ST3ARN specify ganging plates (STGP) separately</p> <p>COM/COL..... 12 1/4 yards, 220 1/2 sq. ft. Seat height 17" Arm height 23 1/2" Seat foam and Dacron Base painted or plated steel</p>	28	86	30	\$7,353	Basic/COM Price does not include fabric. Refer to the upholstery upcharge pages for fabric and COL pricing. 1 yard = 18 sq. ft.
<p>Tuxedo • Sofa arm left, armless right, quilted</p> 	<p>ST3ALQ specify ganging plates (STGP) separately</p> <p>COM/COL..... 12 1/4 yards, 220 1/2 sq. ft. Seat height 17" Arm height 23 1/2" Seat foam and Dacron Base painted or plated steel</p>	28	86	30	\$7,588	Basic/COM Price does not include fabric. Refer to the upholstery upcharge pages for fabric and COL pricing. 1 yard = 18 sq. ft.
<p>Tuxedo • Sofa arm left, armless right, non-quilted</p> 	<p>ST3ALN specify ganging plates (STGP) separately</p> <p>COM/COL..... 12 1/4 yards, 220 1/2 sq. ft. Seat height 17" Arm height 23 1/2" Seat foam and Dacron Base painted or plated steel</p>	28	86	30	\$7,353	Basic/COM Price does not include fabric. Refer to the upholstery upcharge pages for fabric and COL pricing. 1 yard = 18 sq. ft.

Specify

Upholstery
Base Finish
Fire Retardancy (specify NOCAL)

See Geiger occasional tables pricebook for Tuxedo component occasional tables.

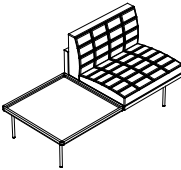
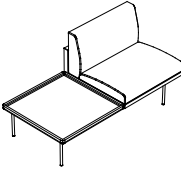
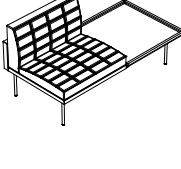
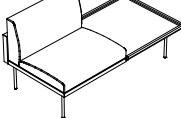
	Product Number	Depth	Width	Height	Basic Price	Upholstery
<p>Tuxedo • Club Chair with Table armless, seat left, table right, quilted</p> 	<p>SX1NLQ specify ganging plates (STGP) separately</p> <p>COM/COL..... 3 3/4 yards, 67 1/2 sq. ft. Seat height 17" Seat HR foam, Dacron, and polyfoam cushions Base painted or plated steel</p>	28	56	30	\$4,756	Basic/COM Price does not include fabric. Refer to the upholstery upcharge pages for fabric and COL pricing. 1 yard = 18 sq. ft.
<p>Tuxedo • Club Chair with Table armless, seat left, table right, non-quilted</p> 	<p>SX1NLN specify ganging plates (STGP) separately</p> <p>COM/COL..... 3 3/4 yards, 67 1/2 sq. ft. Seat height 17" Seat HR foam, Dacron, and polyfoam cushions Base painted or plated steel</p>	28	56	30	\$4,573	Basic/COM Price does not include fabric. Refer to the upholstery upcharge pages for fabric and COL pricing. 1 yard = 18 sq. ft.
<p>Tuxedo • Club Chair with Table armless, seat right, table left, quilted</p> 	<p>SX1NRQ specify ganging plates (STGP) separately</p> <p>COM/COL..... 3 3/4 yards, 67 1/2 sq. ft. Seat height 17" Seat HR foam, Dacron, and polyfoam cushions Base painted or plated steel</p>	28	56	30	\$4,756	Basic/COM Price does not include fabric. Refer to the upholstery upcharge pages for fabric and COL pricing. 1 yard = 18 sq. ft.
<p>Tuxedo • Club Chair with Table armless, seat right, table left, non-quilted</p> 	<p>SX1NRN specify ganging plates (STGP) separately</p> <p>COM/COL..... 3 3/4 yards, 67 1/2 sq. ft. Seat height 17" Seat HR foam, Dacron, and polyfoam cushions Base painted or plated steel</p>	28	56	30	\$4,573	Basic/COM Price does not include fabric. Refer to the upholstery upcharge pages for fabric and COL pricing. 1 yard = 18 sq. ft.

Specify

Wood
Upholstery
Base Finish
Fire Retardancy (specify NOCAL)

See Geiger occasional tables pricebook for Tuxedo component occasional tables.

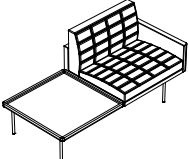
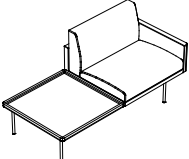
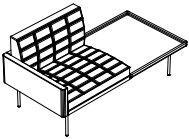
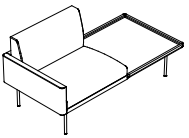
	Product Number	Depth	Width	Height	Basic Price	Upholstery
<p>Tuxedo • Club Chair with Table arm left, table right, quilted</p> 	<p>SX1ALQ specify ganging plates (STGP) separately</p> <p>COM/COL..... 4 3/4 yards, 85 1/2 sq. ft. Seat height 17" Arm height 23 1/2" Seat HR foam, Dacron, and polyfoam cushions Base painted or plated steel</p>	28	58	30	\$5,188	Basic/COM Price does not include fabric. Refer to the upholstery upcharge pages for fabric and COL pricing. 1 yard = 18 sq. ft.
<p>Tuxedo • Club Chair with Table arm left, table right, non-quilted</p> 	<p>SX1ALN specify ganging plates (STGP) separately</p> <p>COM/COL..... 4 3/4 yards, 85 1/2 sq. ft. Seat height 17" Arm height 23 1/2" Seat HR foam, Dacron, and polyfoam cushions Base painted or plated steel</p>	28	58	30	\$5,012	Basic/COM Price does not include fabric. Refer to the upholstery upcharge pages for fabric and COL pricing. 1 yard = 18 sq. ft.
<p>Tuxedo • Club Chair with Table arm right, table left, quilted</p> 	<p>SX1ARQ specify ganging plates (STGP) separately</p> <p>COM/COL..... 4 3/4 yards, 85 1/2 sq. ft. Seat height 17" Arm height 23 1/2" Seat HR foam, Dacron, and polyfoam cushions Base painted or plated steel</p>	28	58	30	\$5,188	Basic/COM Price does not include fabric. Refer to the upholstery upcharge pages for fabric and COL pricing. 1 yard = 18 sq. ft.
<p>Tuxedo • Club Chair with Table arm right, table left, non-quilted</p> 	<p>SX1ARN specify ganging plates (STGP) separately</p> <p>COM/COL..... 4 3/4 yards, 85 1/2 sq. ft. Seat height 17" Arm height 23 1/2" Seat HR foam, Dacron, and polyfoam cushions Base painted or plated steel</p>	28	58	30	\$5,012	Basic/COM Price does not include fabric. Refer to the upholstery upcharge pages for fabric and COL pricing. 1 yard = 18 sq. ft.

Specify

Wood
Upholstery
Base Finish
Fire Retardancy (specify NOCAL)

See Geiger occasional tables pricebook for Tuxedo component occasional tables.

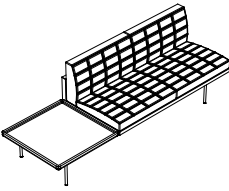
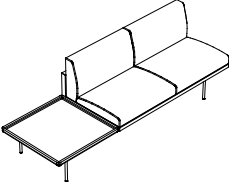
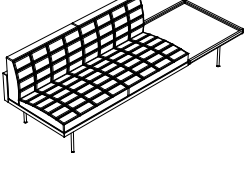
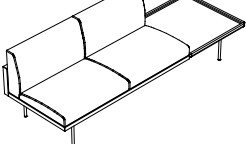
	Product Number	Depth	Width	Height	Basic Price	Upholstery
<p>Tuxedo • Settee with Table armless, seat left, table right, quilted</p> 	<p>SX2NLQ specify ganging plates (STGP) separately</p> <p>COM/COL..... 7 1/2 yards, 135 sq. ft. Seat height 17" Seat HR foam, Dacron, and polyfoam cushions Base painted or plated steel</p>	28	84	30	\$6,460	Basic/COM Price does not include fabric. Refer to the upholstery upcharge pages for fabric and COL pricing. 1 yard = 18 sq. ft.
<p>Tuxedo • Settee with Table armless, seat left, table right, non-quilted</p> 	<p>SX2NLN specify ganging plates (STGP) separately</p> <p>COM/COL..... 7 1/2 yards, 135 sq. ft. Seat height 17" Seat HR foam, Dacron, and polyfoam cushions Base painted or plated steel</p>	28	84	30	\$6,094	Basic/COM Price does not include fabric. Refer to the upholstery upcharge pages for fabric and COL pricing. 1 yard = 18 sq. ft.
<p>Tuxedo • Settee with Table armless, seat right, table left, quilted</p> 	<p>SX2NRQ specify ganging plates (STGP) separately</p> <p>COM/COL..... 7 1/2 yards, 135 sq. ft. Seat height 17" Seat HR foam, Dacron, and polyfoam cushions Base painted or plated steel</p>	28	84	30	\$6,460	Basic/COM Price does not include fabric. Refer to the upholstery upcharge pages for fabric and COL pricing. 1 yard = 18 sq. ft.
<p>Tuxedo • Settee with Table armless, seat right, table left, non-quilted</p> 	<p>SX2NRN specify ganging plates (STGP) separately</p> <p>COM/COL..... 7 1/2 yards, 135 sq. ft. Seat height 17" Seat HR foam, Dacron, and polyfoam cushions Base painted or plated steel</p>	28	84	30	\$6,094	Basic/COM Price does not include fabric. Refer to the upholstery upcharge pages for fabric and COL pricing. 1 yard = 18 sq. ft.

Specify

Wood
Upholstery
Base Finish
Fire Retardancy (specify NOCAL)

See Geiger occasional tables pricebook for Tuxedo component occasional tables.

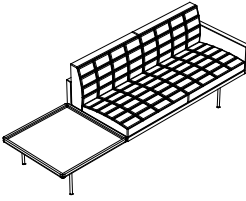
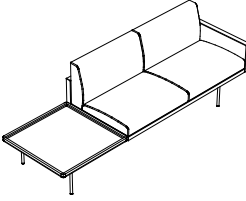
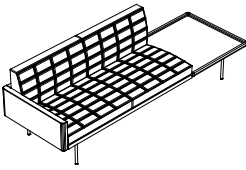
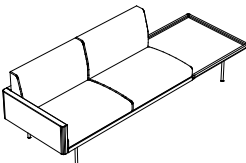
	Product Number	Depth	Width	Height	Basic Price	Upholstery
<p>Tuxedo • Settee with Table arm left, table right, quilted</p> 	<p>SX2ALQ specify ganging plates (STGP) separately</p> <p>COM/COL..... 8 1/2 yards, 153 sq. ft. Seat height 17" Arm height 23 1/2" Seat HR foam, Dacron, and polyfoam cushions Base painted or plated steel</p>	28	86	30	\$6,893	Basic/COM Price does not include fabric. Refer to the upholstery upcharge pages for fabric and COL pricing. 1 yard = 18 sq. ft.
<p>Tuxedo • Settee with Table arm left, table right, non-quilted</p> 	<p>SX2ALN specify ganging plates (STGP) separately</p> <p>COM/COL..... 8 1/2 yards, 153 sq. ft. Seat height 17" Arm height 23 1/2" Seat HR foam, Dacron, and polyfoam cushions Base painted or plated steel</p>	28	86	30	\$6,526	Basic/COM Price does not include fabric. Refer to the upholstery upcharge pages for fabric and COL pricing. 1 yard = 18 sq. ft.
<p>Tuxedo • Settee with Table arm right, table left, quilted</p> 	<p>SX2ARQ specify ganging plates (STGP) separately</p> <p>COM/COL..... 8 1/2 yards, 153 sq. ft. Seat height 17" Arm height 23 1/2" Seat HR foam, Dacron, and polyfoam cushions Base painted or plated steel</p>	28	86	30	\$6,893	Basic/COM Price does not include fabric. Refer to the upholstery upcharge pages for fabric and COL pricing. 1 yard = 18 sq. ft.
<p>Tuxedo • Settee with Table arm right, table left, non-quilted</p> 	<p>SX2ARN specify ganging plates (STGP) separately</p> <p>COM/COL..... 8 1/2 yards, 153 sq. ft. Seat height 17" Arm height 23 1/2" Seat HR foam, Dacron, and polyfoam cushions Base painted or plated steel</p>	28	86	30	\$6,526	Basic/COM Price does not include fabric. Refer to the upholstery upcharge pages for fabric and COL pricing. 1 yard = 18 sq. ft.

Specify

Wood
Upholstery
Base Finish
Fire Retardancy (specify NOCAL)

See Geiger occasional tables pricebook for Tuxedo component occasional tables.

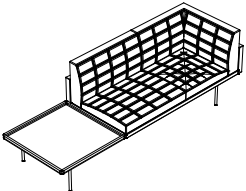
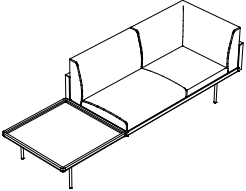
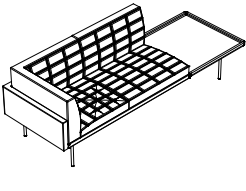
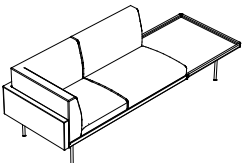
	Product Number	Depth	Width	Height	Basic Price	Upholstery
<p>Tuxedo • Settee with Table corner left, table right, quilted</p> 	<p>SX2CLQ specify ganging plates (STGP) separately</p> <p>COM/COL..... 9 1/4 yards, 166.5 sq. ft. Seat height 17" Arm height 30" Seat HR foam, Dacron, and polyfoam cushions Base painted or plated steel</p>	28	86	30	\$7,746	Basic/COM Price does not include fabric. Refer to the upholstery upcharge pages for fabric and COL pricing. 1 yard = 18 sq. ft.
<p>Tuxedo • Settee with Table corner left, table right, non-quilted</p> 	<p>SX2CLN specify ganging plates (STGP) separately</p> <p>COM/COL..... 9 1/4 yards, 166.5 sq. ft. Seat height 17" Arm height 30" Seat HR foam, Dacron, and polyfoam cushions Base painted or plated steel</p>	28	86	30	\$7,313	Basic/COM Price does not include fabric. Refer to the upholstery upcharge pages for fabric and COL pricing. 1 yard = 18 sq. ft.
<p>Tuxedo • Settee with Table corner right, table left, quilted</p> 	<p>SX2CRQ specify ganging plates (STGP) separately</p> <p>COM/COL..... 9 1/4 yards, 166.5 sq. ft. Seat height 17" Arm height 30" Seat HR foam, Dacron, and polyfoam cushions Base painted or plated steel</p>	28	86	30	\$7,746	Basic/COM Price does not include fabric. Refer to the upholstery upcharge pages for fabric and COL pricing. 1 yard = 18 sq. ft.
<p>Tuxedo • Settee with Table corner right, table left, non-quilted</p> 	<p>SX2CRN specify ganging plates (STGP) separately</p> <p>COM/COL..... 9 1/4 yards, 166.5 sq. ft. Seat height 17" Arm height 30" Seat HR foam, Dacron, and polyfoam cushions Base painted or plated steel</p>	28	86	30	\$7,313	Basic/COM Price does not include fabric. Refer to the upholstery upcharge pages for fabric and COL pricing. 1 yard = 18 sq. ft.

Specify

Wood
Upholstery
Base Finish
Fire Retardancy (specify NOCAL)

See Geiger occasional tables pricebook for Tuxedo component occasional tables.

	Product Number	Depth	Width	Height	Basic Price
Tuxedo • Ganging Plates	STGP	3	5 1/4	3/16	\$107

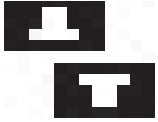

includes two plates and associated screws

Specify

no options

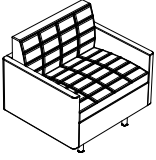
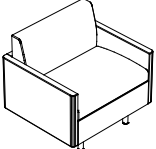
	Product Number	Depth	Width	Height	Basic Price	Upholstery
Tuxedo Classic • Club Chair <i>quilted</i> 	SZ1ABQ	28	32	30	\$3,668	<i>Basic/COM Price does not include fabric. Refer to the upholstery upcharge pages for fabric and COL pricing. 1 yard = 18 sq. ft.</i>
	COM/COL..... 6 1/2 yards, 117 sq. ft. Seat height 17 3/4" Arm height 23" Seat HR foam, Dacron, and polyfoam cushions Base solid ash or walnut					
Tuxedo Classic • Club Chair <i>non-quilted</i> 	SZ1ABN	28	32	30	\$3,483	<i>Basic/COM Price does not include fabric. Refer to the upholstery upcharge pages for fabric and COL pricing. 1 yard = 18 sq. ft.</i>
	COM/COL..... 6 1/2 yards, 117 sq. ft. Seat height 17 3/4" Arm height 23" Seat HR foam, Dacron, and polyfoam cushions Base solid ash or walnut					

Specify

Upholstery
 Base
 Fire Retardancy (specify NOCAL)

See Geiger occasional tables pricebook for Tuxedo component occasional tables.

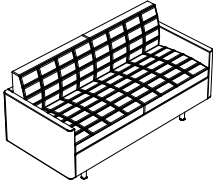
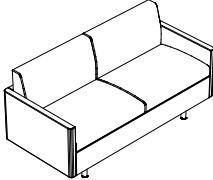
	Product Number	Depth	Width	Height	Basic Price	Upholstery
Tuxedo Classic • Settee <i>quilted</i> 	SZ2ABQ	28	60	30	\$5,884	<i>Basic/COM Price does not include fabric. Refer to the upholstery upcharge pages for fabric and COL pricing. 1 yard = 18 sq. ft.</i> COM/COL..... 10 1/2 yards, 189 sq. ft. Seat height 17 3/4" Arm height 23" Seat HR foam, Dacron, and polyfoam cushions Base solid ash or walnut
Tuxedo Classic • Settee <i>non-quilted</i> 	SZ2ABN	28	60	30	\$5,522	<i>Basic/COM Price does not include fabric. Refer to the upholstery upcharge pages for fabric and COL pricing. 1 yard = 18 sq. ft.</i> COM/COL..... 10 1/2 yards, 189 sq. ft. Seat height 17 3/4" Arm height 23" Seat HR foam, Dacron, and polyfoam cushions Base solid ash or walnut

Specify

Upholstery
 Base
 Fire Retardancy (specify NOCAL)

See Geiger occasional tables pricebook for Tuxedo component occasional tables.

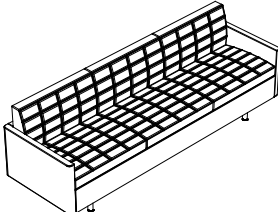
	Product Number	Depth	Width	Height	Basic Price	Upholstery
Tuxedo Classic • Sofa <i>quilted</i> 	SZ3ABQ	28	88	30	\$7,936	<i>Basic/COM Price does not include fabric. Refer to the upholstery upcharge pages for fabric and COL pricing. 1 yard = 18 sq. ft.</i>
	COM/COL..... 14 yards, 252 sq. ft. Seat height 17 3/4" Arm height 23" Seat HR foam, Dacron, and polyfoam cushions Base solid ash or walnut					

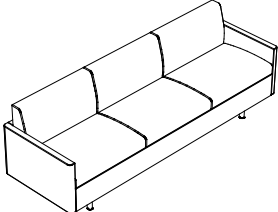
Tuxedo Classic • Sofa <i>non-quilted</i> 	SZ3ABN	28	88	30	\$7,392	<i>Basic/COM Price does not include fabric. Refer to the upholstery upcharge pages for fabric and COL pricing. 1 yard = 18 sq. ft.</i>
	COM/COL..... 14 yards, 252 sq. ft. Seat height 17 3/4" Arm height 23" Seat HR foam, Dacron, and polyfoam cushions Base solid ash or walnut					

Specify

Upholstery

Base

Fire Retardancy (specify NOCAL)

See Geiger occasional tables pricebook for Tuxedo component occasional tables.

	Product Number	Depth	Width	Height	Basic Price	Upholstery
Tuxedo Classic • Connecting Settee <i>armless, quilted</i>	SZ2ANQ <i>connects to adjacent seat on right and left</i>	28	56	30	\$4,867	<i>Basic/COM Price does not include fabric. Refer to the upholstery upcharge pages for fabric and COL pricing. 1 yard = 18 sq. ft.</i>
<i>COM/COL..... 8 yards, 144 sq. ft.</i> <i>Seat height 17 3/4"</i> <i>Seat..... HR foam, Dacron, and polyfoam cushions</i> <i>Base solid ash or walnut</i>						

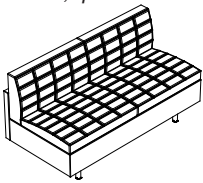

Tuxedo Classic • Connecting Settee <i>armless, non-quilted</i>	SZ2ANN <i>connects to adjacent seat on right and left</i>	28	56	30	\$4,500	<i>Basic/COM Price does not include fabric. Refer to the upholstery upcharge pages for fabric and COL pricing. 1 yard = 18 sq. ft.</i>
<i>COM/COL..... 8 yards, 144 sq. ft.</i> <i>Seat height 17 3/4"</i> <i>Seat..... HR foam, Dacron, and polyfoam cushions</i> <i>Base solid ash or walnut</i>						

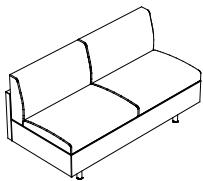

Specify

Upholstery

Base

Fire Retardancy (specify NOCAL)

See Geiger occasional tables pricebook for Tuxedo component occasional tables.

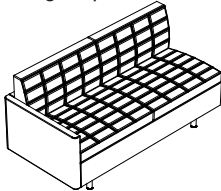
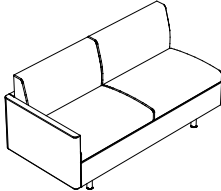
	Product Number	Depth	Width	Height	Basic Price	Upholstery
Tuxedo Classic • Connecting Settee arm right, quilted 	SZ2ARQ connects to adjacent seat on left COM/COL..... 9 1/4 yards, 166 1/2 sq. ft. Seat height 17 3/4" Arm height 23" Seat HR foam, Dacron, and polyfoam cushions Base solid ash or walnut	28	58	30	\$5,371	<i>Basic/COM Price does not include fabric. Refer to the upholstery upcharge pages for fabric and COL pricing. 1 yard = 18 sq. ft.</i>
Tuxedo Classic • Connecting Settee arm right non-quilted 	SZ2ARN connects to adjacent seat on left COM/COL..... 9 1/4 yards, 166 1/2 sq. ft. Seat height 17 3/4" Arm height 23" Seat HR foam, Dacron, and polyfoam cushions Base solid ash or walnut	28	58	30	\$5,012	<i>Basic/COM Price does not include fabric. Refer to the upholstery upcharge pages for fabric and COL pricing. 1 yard = 18 sq. ft.</i>

Specify

Upholstery
 Base
 Fire Retardancy (specify NOCAL)

See Geiger occasional tables pricebook for Tuxedo component occasional tables.

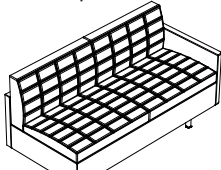
	Product Number	Depth	Width	Height	Basic Price	Upholstery
Tuxedo Classic • Connecting Settee arm left, quilted 	SZ2ALQ connects to adjacent seat on right COM/COL..... 9 1/4 yards, 166 1/2 sq. ft. Seat height 17 3/4" Arm height 23" Seat HR foam, Dacron, and polyfoam cushions Base solid ash or walnut	28	58	30	\$5,371	<i>Basic/COM Price does not include fabric. Refer to the upholstery upcharge pages for fabric and COL pricing. 1 yard = 18 sq. ft.</i>

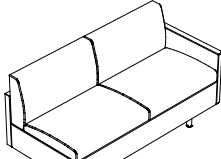
Tuxedo Classic • Connecting Settee arm left, non-quilted 	SZ2ALN connects to adjacent seat on right COM/COL..... 9 1/4 yards, 166 1/2 sq. ft. Seat height 17 3/4" Arm height 23" Seat HR foam, Dacron, and polyfoam cushions Base solid ash or walnut	28	58	30	\$5,287	<i>Basic/COM Price does not include fabric. Refer to the upholstery upcharge pages for fabric and COL pricing. 1 yard = 18 sq. ft.</i>
--	--	----	----	----	---------	--

Specify

Upholstery
 Base
 Fire Retardancy (specify NOCAL)

See Geiger occasional tables pricebook for Tuxedo component occasional tables.

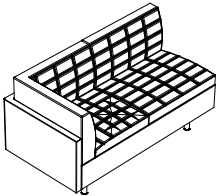
	Product Number	Depth	Width	Height	Basic Price	Upholstery
Tuxedo Classic • Connecting Corner Settee corner right, armless left, quilted 	SZ2CRQ connects to adjacent seat on left and right COM/COL..... 10 1/2 yards, 189 sq. ft. Seat height 17 3/4" Arm height 23" Seat Height..... 17 3/4" Seat..... HR foam, Dacron, and polyfoam cushions Base solid ash or walnut	28	56	30	\$6,106	<i>Basic/COM Price does not include fabric. Refer to the upholstery upcharge pages for fabric and COL pricing. 1 yard = 18 sq. ft.</i>

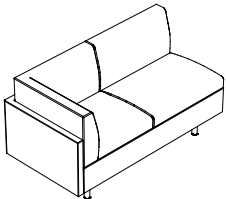
Tuxedo Classic • Connecting Corner Settee corner right, armless left, non-quilted 	SZ2CRN connects to adjacent seat on left and right COM/COL..... 10 1/2 yards, 189 sq. ft. Seat height 17 3/4" Arm height 23" Seat Height..... 17 3/4" Seat..... HR foam, Dacron, and polyfoam cushions Base solid ash or walnut	28	56	30	\$5,674	<i>Basic/COM Price does not include fabric. Refer to the upholstery upcharge pages for fabric and COL pricing. 1 yard = 18 sq. ft.</i>
---	---	----	----	----	---------	--

Specify

Upholstery
 Base
 Fire Retardancy (specify NOCAL)

See Geiger occasional tables pricebook for Tuxedo component occasional tables.

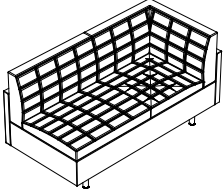
	Product Number	Depth	Width	Height	Basic Price	Upholstery
Tuxedo Classic • Connecting Corner Settee corner left, armless right, quilted	SZ2CLQ connects to adjacent seat on left and right	28	56	30	\$6,106	<i>Basic/COM Price does not include fabric. Refer to the upholstery upcharge pages for fabric and COL pricing. 1 yard = 18 sq. ft.</i>
	COM/COL..... 10 1/2 yards, 189 sq. ft. Seat height 17 3/4" Arm height 23" Seat Height..... 17 3/4" Seat..... HR foam, Dacron, and polyfoam cushions Base solid ash or walnut					

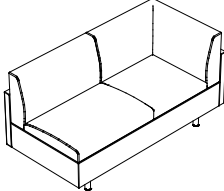
Tuxedo Classic • Connecting Corner Settee corner left, armless right, non-quilted	SZ2CLN connects to adjacent seat on left and right	28	56	30	\$5,674	<i>Basic/COM Price does not include fabric. Refer to the upholstery upcharge pages for fabric and COL pricing. 1 yard = 18 sq. ft.</i>
	COM/COL..... 10 1/2 yards, 189 sq. ft. Seat height 17 3/4" Arm height 23" Seat Height..... 17 3/4" Seat..... HR foam, Dacron, and polyfoam cushions Base solid ash or walnut					

Specify

Upholstery
 Base
 Fire Retardancy (specify NOCAL)

See Geiger occasional tables pricebook for Tuxedo component occasional tables.

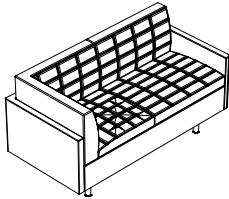
	Product Number	Depth	Width	Height	Basic Price	Upholstery
Tuxedo Classic • Connecting Corner Settee <i>corner right, arm left, quilted</i>	SZ2ZRQ <i>connects to adjacent seat on right</i>	28	58	30	\$6,611	<i>Basic/COM Price does not include fabric. Refer to the upholstery upcharge pages for fabric and COL pricing. 1 yard = 18 sq. ft.</i>
	COM/COL..... 11 3/4 yards, 211 1/2 sq. ft. Seat height 17 3/4" Arm height 23" Seat Height..... 17 3/4" Seat HR foam, Dacron, and polyfoam cushions Base solid ash or walnut					

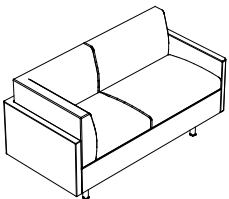
Tuxedo Classic • Connecting Corner Settee <i>corner right, arm left, non-quilted</i>	SZ2ZRN <i>connects to adjacent seat on right</i>	28	58	30	\$6,178	<i>Basic/COM Price does not include fabric. Refer to the upholstery upcharge pages for fabric and COL pricing. 1 yard = 18 sq. ft.</i>
	COM/COL..... 11 3/4 yards, 211 1/2 sq. ft. Seat height 17 3/4" Arm height 23" Seat Height..... 17 3/4" Seat HR foam, Dacron, and polyfoam cushions Base solid ash or walnut					

Specify

Upholstery

Base

Fire Retardancy (specify NOCAL)

See Geiger occasional tables pricebook for Tuxedo component occasional tables.

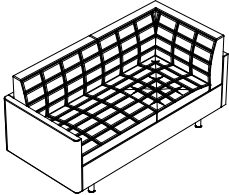
	Product Number	Depth	Width	Height	Basic Price	Upholstery
Tuxedo Classic • Connecting Corner Settee corner left, arm right, quilted 	SZ2ZLQ connects to adjacent seat on left COM/COL..... 11 3/4 yards, 211 1/2 sq. ft. Seat height 17 3/4" Arm height 23" Seat Height..... 17 3/4" Seat HR foam, Dacron, and polyfoam cushions Base solid ash or walnut	28	58	30	\$6,449	<i>Basic/COM Price does not include fabric. Refer to the upholstery upcharge pages for fabric and COL pricing. 1 yard = 18 sq. ft.</i>

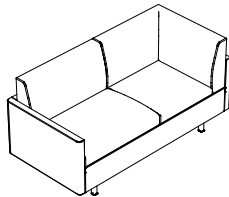
Tuxedo Classic • Connecting Corner Settee corner left, arm right, non-quilted 	SZ2ZLN connects to adjacent seat on left COM/COL..... 11 3/4 yards, 211 1/2 sq. ft. Seat height 17 3/4" Arm height 23" Seat Height..... 17 3/4" Seat HR foam, Dacron, and polyfoam cushions Base solid ash or walnut	28	58	30	\$6,178	<i>Basic/COM Price does not include fabric. Refer to the upholstery upcharge pages for fabric and COL pricing. 1 yard = 18 sq. ft.</i>
---	--	----	----	----	---------	--

Specify

Upholstery
 Base
 Fire Retardancy (specify NOCAL)

See Geiger occasional tables pricebook for Tuxedo component occasional tables.

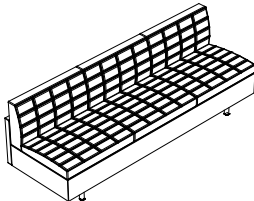
	Product Number	Depth	Width	Height	Basic Price	Upholstery
Tuxedo Classic • Connecting Sofa <i>armless, quilted</i>	SZ3ANQ <i>connects to adjacent seat on left and right</i>	28	84	30	\$6,925	<i>Basic/COM Price does not include fabric. Refer to the upholstery upcharge pages for fabric and COL pricing. 1 yard = 18 sq. ft.</i>
	COM/COL..... 11 1/2 yards, 207 sq. ft. Seat height 17 3/4" Seat HR foam, Dacron, and polyfoam cushions Base solid ash or walnut					

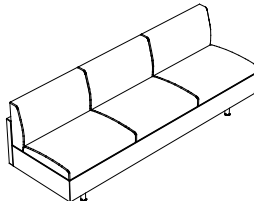
Tuxedo Classic • Connecting Sofa <i>armless, non-quilted</i>	SZ3ANN <i>connects to adjacent seat on left and right</i>	28	84	30	\$6,230	<i>Basic/COM Price does not include fabric. Refer to the upholstery upcharge pages for fabric and COL pricing. 1 yard = 18 sq. ft.</i>
	COM/COL..... 11 1/2 yards, 207 sq. ft. Seat height 17 3/4" Seat HR foam, Dacron, and polyfoam cushions Base solid ash or walnut					

Specify

Upholstery
 Base
 Fire Retardancy (specify NOCAL)

See Geiger occasional tables pricebook for Tuxedo component occasional tables.

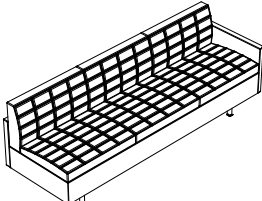
	Product Number	Depth	Width	Height	Basic Price	Upholstery
Tuxedo Classic • Connecting Sofa <i>arm left, quilted</i> 	SZ3ALQ <i>connects to adjacent seat on right</i>	28	86	30	\$7,424	<i>Basic/COM Price does not include fabric. Refer to the upholstery upcharge pages for fabric and COL pricing. 1 yard = 18 sq. ft.</i>
	COM/COL..... 12 3/4 yards, 229 1/2 sq. ft. Seat height 17 3/4" Arm height 23" Seat HR foam, Dacron, and polyfoam cushions Base solid ash or walnut					

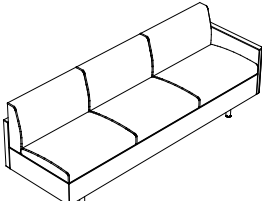
Tuxedo Classic • Connecting Sofa <i>arm left, non-quilted</i> 	SZ3ALN <i>connects to adjacent seat on right</i>	28	86	30	\$6,887	<i>Basic/COM Price does not include fabric. Refer to the upholstery upcharge pages for fabric and COL pricing. 1 yard = 18 sq. ft.</i>
	COM/COL..... 12 3/4 yards, 229 1/2 sq. ft. Seat height 17 3/4" Arm height 23" Seat HR foam, Dacron, and polyfoam cushions Base solid ash or walnut					

Specify

Upholstery

Base

Fire Retardancy (specify NOCAL)

See Geiger occasional tables pricebook for Tuxedo component occasional tables.

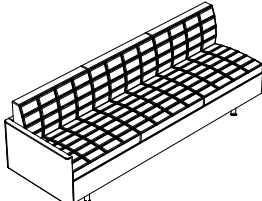
	Product Number	Depth	Width	Height	Basic Price	Upholstery
Tuxedo Classic • Connecting Sofa arm right, quilted 	SZ3ARQ connects to adjacent seat on left COM/COL..... 12 3/4 yards, 229 1/2 sq. ft. Seat height 17 3/4" Arm height 23" Seat HR foam, Dacron, and polyfoam cushions Base solid ash or walnut	28	86	30	\$7,424	<i>Basic/COM Price does not include fabric. Refer to the upholstery upcharge pages for fabric and COL pricing. 1 yard = 18 sq. ft.</i>

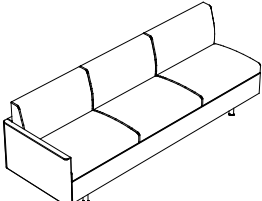
Tuxedo Classic • Connecting Sofa arm right, non-quilted 	SZ3ARN connects to adjacent seat on left COM/COL..... 12 3/4 yards, 229 1/2 sq. ft. Seat height 17 3/4" Arm height 23" Seat HR foam, Dacron, and polyfoam cushions Base solid ash or walnut	28	86	30	\$6,887	<i>Basic/COM Price does not include fabric. Refer to the upholstery upcharge pages for fabric and COL pricing. 1 yard = 18 sq. ft.</i>
---	--	----	----	----	---------	--

Specify

Upholstery
 Base
 Fire Retardancy (specify NOCAL)

See Geiger occasional tables pricebook for Tuxedo component occasional tables.

	Product Number	Depth	Width	Height	Basic Price	Upholstery
Tuxedo Classic • Connecting Corner Sofa corner right, armless left, quilted	SZ3CRQ connects to adjacent seat on left and right	28	84	30	\$8,105	<i>Basic/COM Price does not include fabric. Refer to the upholstery upcharge pages for fabric and COL pricing. 1 yard = 18 sq. ft.</i>

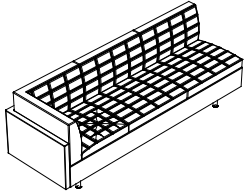

COM/COL..... 14 1/2 yards, 261 sq. ft.
 Seat height 17 3/4"
 Seat..... HR foam, Dacron, and polyfoam cushions
 Base solid ash or walnut

Tuxedo Classic • Connecting Corner Sofa corner right, armless left, non-quilted	SZ3CRN connects to adjacent seat on left and right	28	84	30	\$7,489	<i>Basic/COM Price does not include fabric. Refer to the upholstery upcharge pages for fabric and COL pricing. 1 yard = 18 sq. ft.</i>
---	--	----	----	----	---------	--

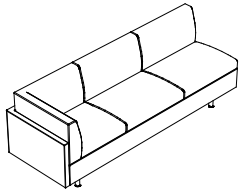

COM/COL..... 14 1/2 yards, 261 sq. ft.
 Seat height 17 3/4"
 Seat..... HR foam, Dacron, and polyfoam cushions
 Base solid ash or walnut

Specify

Upholstery

Base

Fire Retardancy (specify NOCAL)

See Geiger occasional tables pricebook for Tuxedo component occasional tables.

	Product Number	Depth	Width	Height	Basic Price	Upholstery
Tuxedo Classic • Connecting Corner Sofa corner left, armless right, quilted	SZ3CLQ connects to adjacent seat on left and right	28	84	30	\$8,105	<i>Basic/COM Price does not include fabric. Refer to the upholstery upcharge pages for fabric and COL pricing. 1 yard = 18 sq. ft.</i>

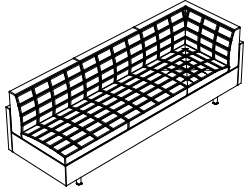

COM/COL..... 14 1/2 yards, 261 sq. ft.
 Seat height 17 3/4"
 Seat HR foam, Dacron, and polyfoam cushions
 Base solid ash or walnut

Tuxedo Classic • Connecting Corner Sofa corner left, armless right, non-quilted	SZ3CLN connects to adjacent seat on left and right	28	84	30	\$7,489	<i>Basic/COM Price does not include fabric. Refer to the upholstery upcharge pages for fabric and COL pricing. 1 yard = 18 sq. ft.</i>
---	--	----	----	----	---------	--

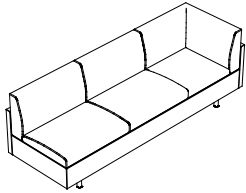

COM/COL..... 14 1/2 yards, 261 sq. ft.
 Seat height 17 3/4"
 Seat HR foam, Dacron, and polyfoam cushions
 Base solid ash or walnut

Specify

Upholstery
 Base
 Fire Retardancy (specify NOCAL)

See Geiger occasional tables pricebook for Tuxedo component occasional tables.

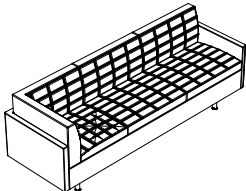
	Product Number	Depth	Width	Height	Basic Price	Upholstery
Tuxedo Classic • Connecting Corner Sofa corner right, arm left, quilted 	SZ3ZRQ connects to adjacent seat on right COM/COL..... 15 3/4 yards, 283 1/2 sq. ft. Seat height 17 3/4" Arm height 23" Seat HR foam, Dacron, and polyfoam cushions Base solid ash or walnut	28	86	30	\$8,610	<i>Basic/COM Price does not include fabric. Refer to the upholstery upcharge pages for fabric and COL pricing. 1 yard = 18 sq. ft.</i>

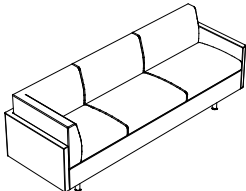
Tuxedo Classic • Connecting Corner Sofa corner right, arm left, non-quilted 	SZ3ZRN connects to adjacent seat on right COM/COL..... 15 3/4 yards, 283 1/2 sq. ft. Seat height 17 3/4" Arm height 23" Seat HR foam, Dacron, and polyfoam cushions Base solid ash or walnut	28	86	30	\$7,988	<i>Basic/COM Price does not include fabric. Refer to the upholstery upcharge pages for fabric and COL pricing. 1 yard = 18 sq. ft.</i>
---	---	----	----	----	---------	--

Specify

Upholstery

Base

Fire Retardancy (specify NOCAL)

See Geiger occasional tables pricebook for Tuxedo component occasional tables.

	Product Number	Depth	Width	Height	Basic Price	Upholstery
Tuxedo Classic • Connecting Corner Sofa <i>corner left, arm right, quilted</i>	SZ3ZLQ <i>connects to adjacent seat on left</i>	28	86	30	\$8,610	<i>Basic/COM Price does not include fabric. Refer to the upholstery upcharge pages for fabric and COL pricing. 1 yard = 18 sq. ft.</i>

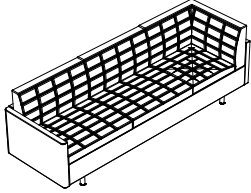

COM/COL..... 15 3/4 yards, 283 1/2 sq. ft.
 Seat height 17 3/4"
 Arm height 23"
 Seat HR foam, Dacron, and polyfoam cushions
 Base solid ash or walnut

Tuxedo Classic • Connecting Corner Sofa <i>corner left, arm right, non-quilted</i>	SZ3ZLN <i>connects to adjacent seat on left</i>	28	86	30	\$7,988	<i>Basic/COM Price does not include fabric. Refer to the upholstery upcharge pages for fabric and COL pricing. 1 yard = 18 sq. ft.</i>
--	---	----	----	----	---------	--

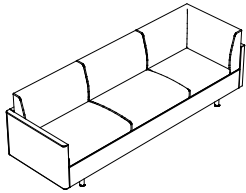



COM/COL..... 15 3/4 yards, 283 1/2 sq. ft.
 Seat height 17 3/4"
 Arm height 23"
 Seat HR foam, Dacron, and polyfoam cushions
 Base solid ash or walnut

Specify

Upholstery
 Base
 Fire Retardancy (specify NOCAL)

See Geiger occasional tables pricebook for Tuxedo component occasional tables.

	Product Number	Depth	Width	Height	Basic Price	Upholstery
 	U-Series • Lounge Chair					
	2003	29 1/2	31	23 1/4	\$2,691	<i>Basic/COM Price does not include fabric. Refer to the upholstery upcharge pages for fabric and COL pricing. 1 yard = 18 sq. ft.</i>
	<i>with casters</i>					
	2004	29 1/2	31	23 1/4	\$2,821	
		COM/COL (Shell back)..... 3 yards, 54 sq. ft. COM/COL (Seat cushion, arm) 3. 1/2 yards, 63 sq. ft. Seat height 16 1/4" Arm height 23 1/4"				
	U-Series • Settee					
	2006	29 1/2	60 1/4	23 1/4	\$4,068	<i>Basic/COM Price does not include fabric. Refer to the upholstery upcharge pages for fabric and COL pricing. 1 yard = 18 sq. ft.</i>
		COM/COL (Shell back)..... 4 3/4 yards, 85 1/2 sq. ft. COM/COL (Seat cushion, arm) 4 1/4 yards, 76 1/2 sq. ft. Seat height 16 1/4" Arm height 23 1/4"				
	U-Series • Sofa					
	2007	29 1/2	84 1/4	23 1/4	\$5,246	<i>Basic/COM Price does not include fabric. Refer to the upholstery upcharge pages for fabric and COL pricing. 1 yard = 18 sq. ft.</i>
		COM/COL (Shell back)..... 5 3/4 yards, 94 1/2 sq. ft. COM/COL (Seat cushion, arm) 5 1/4 yards, 85 1/2 sq. ft. Seat height 16 1/4" Arm height 23 1/4"				

Specify

Upholstery 1 (Shell back)
 Upholstery 2 (Seat cushion, arm)
 Fire Retardancy (specify NOCAL)

Product Number	Page	Product Number	Page	Product Number	Page	Product Number	Page
2003.....	82	SK4B.....	39	ST3ARN.....	58	SZ1ABN.....	65
2004.....	82	SK5.....	41	ST3ARQ.....	58	SZ1ABQ.....	65
2006.....	82	SK6.....	40	ST3BN.....	49	SZ2ABN.....	66
2007.....	82	SSJFA.....	32	ST3BQ.....	49	SZ2ABQ.....	66
PTA.....	35	SSJFF.....	32	ST3CLAN.....	56	SZ2ALN.....	70
PTB.....	35	SSJFW.....	32	ST3CLAQ.....	56	SZ2ALQ.....	70
PTC.....	35	SSJGA.....	32	ST3CLNN.....	57	SZ2ANN.....	68
PTD.....	35	SSJGF.....	32	ST3CLNQ.....	57	SZ2ANQ.....	68
SBN5H.....	44	SSJGW.....	32	ST3CRAN.....	56	SZ2ARN.....	69
SBN6.....	45	SSJJA.....	33	ST3CRAQ.....	56	SZ2ARQ.....	69
SBR4N.....	31	SSJFF.....	33	ST3CRNN.....	57	SZ2CLN.....	72
SBRA-43.....	43	SSJJW.....	33	ST3CRNQ.....	57	SZ2CLQ.....	72
SBRA-72.....	43	SSJKA.....	33	ST3DN.....	49	SZ2CRN.....	71
SBRA-84.....	43	SSJKF.....	33	ST3DQ.....	49	SZ2CRQ.....	71
SBRA-96.....	43	SSJKW.....	33	ST3NN.....	55	SZ2ZLN.....	74
SBSC-1098.....	46	ST1AN.....	50	ST3NQ.....	55	SZ2ZLQ.....	74
SBSD-1099.....	46	ST1AQ.....	50	STGP.....	64	SZ2ZRN.....	73
SBSU-1060.....	47	ST1BN.....	48	SVV4A.....	28	SZ2ZRQ.....	73
SBWN-13125.....	82	ST1BQ.....	48	SVV4W.....	28	SZ3ABN.....	67
SBWN-13128.....	82	ST1NN.....	50	SVV5A.....	29	SZ3ABQ.....	67
SBWN-13130.....	82	ST1NQ.....	50	SVV5W.....	29	SZ3ALN.....	76
SES1A.....	34	ST2ALN.....	54	SVV6A.....	30	SZ3ALQ.....	76
SES1W.....	34	ST2ALQ.....	54	SVV6W.....	30	SZ3ANN.....	75
SES3A.....	34	ST2AN.....	51	SX1ALN.....	60	SZ3ANQ.....	75
SES3W.....	34	ST2AQ.....	51	SX1ALQ.....	60	SZ3ARN.....	77
SES4A.....	34	ST2ARN.....	54	SX1ARN.....	60	SZ3ARQ.....	77
SES4W.....	34	ST2ARQ.....	54	SX1ARQ.....	60	SZ3CLN.....	79
SJAA.....	42	ST2BN.....	48	SX1NLN.....	59	SZ3CLQ.....	79
SJAW.....	42	ST2BQ.....	48	SX1NLQ.....	59	SZ3CRN.....	78
SJBA.....	42	ST2CLAN.....	52	SX1NRN.....	59	SZ3CRQ.....	78
SJBW.....	42	ST2CLAQ.....	52	SX1NRQ.....	59	SZ3ZLN.....	81
SJCA.....	42	ST2CLNN.....	53	SX2ALN.....	62	SZ3ZLQ.....	81
SJCW.....	42	ST2CLNQ.....	53	SX2ALQ.....	62	SZ3ZRN.....	80
SK1.....	36	ST2CRAN.....	52	SX2ARN.....	62	SZ3ZRQ.....	80
SK2A.....	37	ST2CRAQ.....	52	SX2ARQ.....	62	TT1AA.....	83
SK2CL.....	37	ST2CRNN.....	53	SX2CLN.....	63	TT1AW.....	83
SK2CR.....	37	ST2CRNQ.....	53	SX2CLQ.....	63	TT1BA.....	83
SK2N.....	37	ST2NN.....	51	SX2CRN.....	63	TT1BW.....	83
SK3A.....	38	ST2NQ.....	51	SX2CRQ.....	63	TT2AA.....	84
SK3CL.....	38	ST3ALN.....	58	SX2NLN.....	61	TT2AW.....	84
SK3CR.....	38	ST3ALQ.....	58	SX2NLQ.....	61	TT3AA.....	84
SK3N.....	38	ST3AN.....	55	SX2NRN.....	61	TT3AW.....	84
SK4A.....	39	ST3AQ.....	55	SX2NRQ.....	61		

- © 2023 Geiger International, Inc. All rights reserved.
- ® Geiger International is a registered trademark of Geiger International, Inc.
- ® Herman Miller is a registered trademark of Herman Miller, Inc.
- ® Edelman Leather is a registered trademark of Edelman Leather, LLC.
- ® DACRON is a registered trademark of INVISTA S.a r.l.
- ™ Brabo, Bumper, Clamshell, Crosshatch, Museum Bench, Nessel, Rapport, Rolled Arm, Saiba, Scissor, Sled, Tuxedo Classic Lounge, Tuxedo Component Lounge, Washington Avenue and Wood Base are trademarks of Geiger International, Inc., and/or of its independent designers.
- ™ The Geiger logo and Bristol are trademarks of Geiger International, Inc., and/or of its independent designers.
- ™ Bento, Chain, Cord, Crossing, Glaze, Glisten, Gloss, Grasscloth, Grosgrain, Herman Miller Leather, Hopsak, Horizon, Lanalux, Linomix, Loft, MCL Leather, Noble, Railroad, Savannah, Sironetta, Slant, Strata, Superweave, and Twist are trademarks of Herman Miller, Inc., and/or of its independent designers.
- ™ A Band Apart, Abacus, Abacus Standard, Across, Agency, Akimbo, Alloy, Allusion, Alpaca Epingle, Alpaca Herringbone, Alpaca Velvet, Alter, Anagram, Apt, Aria, Article, Bavaria, Bavaria Stripe, Beam, Bespoke Stripe, Big Stripe, Blip, Blumen, Borders, Brindle, Brushed Camel, Brushed Merino, Canvas, Centric, Checker, Checker Split, Chenille Cord, Circuit, Coach Cloth, Cobblestone, Coincide, Coincide High Performance, Colline, Colorwheel, Compartment, Cotton Velvet, Couple, Crew, Crush, Dandy, Dart, Deconstructed Rose, Design 9297, Dingbats, Disperse, Ditto, Divina MD, Double Triangles, Dwell, Epingle , Epingle Stripe, Exaggerated Plaid, Exchange, Facets, Floret, Fluent, Fluent Crypton, Focus, Garden, Geometri, Gradient, Hallingdal, Harlow, Herringbone Stripe, Hours, Ingenua, Instill, Jacobs Coat, Kindred, Layers Garden, Layers Garden Double, Layers Park, Layers Park Double, Layers Vineyard, Layers Vineyard Small, Ledger, Letters, Manner, Massive Paisley, Mechanism, Melange Tweed, Meld, Metric, Milestone, Millerstripe, Minimal, Mister, Mode, Mohair Supreme, Monk's Wool, Murmur, Octave, Offset, Omen, Optik, Orakelblume, Ottoman Stripe, Overture, Painted Stripe, Parched Silk, Pare, Paver, Pitch, Plait, Point, Regatta, Repeat Classic Stripe, Repeat Dot Ring, Rove, Rule, Runner, Runner Standard, Salon, Scuba, Sequence, Shuttle Standard, Silk Canvas, Skein, Soft Tweed, Steady, Steady Crypton, Steelcut, Steelcut Trio, Strand, Stripes, Sudden, Tack, Tangram, Telary, The Firm, The Story of My Life, Tonica, Tonus, Toostripe, Topas, Trait, Transport, Trees, Trio, Unisol, Urban, Vases, Vineyard, Vionette, Voyage, Waterborn, Wool Rib, and Wool Velvet are trademarks of Maharam, Inc. and/or of its independent designers.
Edelman and VisionKnit are property of their respective companies. All rights reserved.
- Edelman, Guilford of Maine, and Maharam are property of their respective companies. All rights reserved.