



## Domino Desks, Tables & Storage

Prices effective November 1, 2021

Published November 1, 2021

General Information.....	2
How to Specify.....	4
Specification Notes.....	4
Base Finishes.....	5
Pull Finishes.....	5
Leather and Drawer Finishes.....	6
Wood Finishes.....	8
Tables.....	10
Desks.....	11
Credenzas.....	13
Sideboards.....	19
Index.....	25

#### Application of Standard Terms

Only the standard terms of sale stated in this catalog apply to any transaction unless those terms are modified or supplemented by a written document signed by an officer of Geiger International, Inc. ("Geiger"). Any terms contained in Customer's purchase order, including standard printed provisions, that are additional to or contrary to these terms, are not effective.

#### Use of Furniture and Materials

Geiger assumes that textiles, leathers and products are intended for commercial use and are not being bought for use primarily for personal, family, or household purposes. When installed and used as intended, products remain chattel property, are not considered fixtures, and no interest in them should arise under applicable real estate law.

#### Furniture Prices

Prices are determined by using the published list prices in effect when Geiger receives Customer's completed purchase order. If Customer's requested ship date is more than three months after Geiger receives Customer's order, it may be repriced using the list prices in effect when products ship. If Customer designates special finishes or options, additional charges may apply. Services such as design, project management, packaging, storage, inside delivery, double handling, installation, or inventory management are not included in Geiger's list prices.

#### COM / COL Procedures

If an order includes Customer-supplied materials, Customer must ship those materials to Geiger at Customer's own expense. The materials must be tagged with Geiger's confirmation number, item number, Customer's name, and purchase order number. Geiger is not liable for inadequacies in Customer's materials. Geiger will notify Customer of any apparent defects in Customer's materials before manufacturing.

#### Taxes

Customer is responsible for any local sales taxes or other similar taxes imposed on transactions.

#### Delays

Geiger is not liable for failure to ship by the acknowledged shipping date or any other date. Geiger is not liable for a delay or failure in shipment or performance if the delay or failure is caused by acts of omission of Customer, its agents, employees, contractors, a governmental authority, or God; delays in transportation; or other similar causes that are not within Geiger's reasonable control. Geiger is excused from further performance of its obligations for the duration of a force majeure cause.

#### Changes and Cancellation

Geiger's acceptance of an order is final and binding and an order may not be changed or canceled without Geiger's written consent.

Orders placed on any of Geiger's expedited shipment programs and orders of custom-dyed or custom-woven materials may not be changed or canceled. To change or cancel other orders, contact Geiger Customer Care in writing for authorization and applicable charges.

#### Storage

If Customer cannot accept delivery when products are ready, it is the customer's responsibility to transfer products to storage and products are invoiced at that time. Customer is responsible for actual storage charges and any other expenses relating to the storage of products or materials. Customer bears all risk of loss for products or materials in storage.

#### Freight Terms

For casegoods and seating orders shipped within the 48 contiguous United States, surface freight charges are included. For textile and leather orders actual freight charges will be invoiced. Orders are shipped via ground carrier unless requested otherwise.

For orders shipped to Alaska or Hawaii, the freight terms stated above apply only to the port of embarkation. Shipments beyond that point are freight collect. Domestic deliveries are shipped FOB Geiger's plant to a destination designated by Customer by a method Geiger selects.

All textile shipments will be made FOB Geiger Textiles, Yaphank, NY 11980. All leather shipments will be made FOB Geiger Textiles, Hildebran, NC 28637.

#### Packaging and Shipping

Geiger's casegoods products are shipped in component form. Shipments over \$50,000 net are blanket wrapped. Tops and panels are shrink wrapped with cardboard corner protection. Pedestals, storage units, overheads and vertical storage units are wrapped in blankets and shrink wrapped with cardboard corner protection. Blankets are to be returned to Geiger for reuse. If the customer request cartoning on orders over \$50,000 net, there will be a charge of five percent of the net order. Packing materials are recyclable.

Shipments from Geiger Atlanta under \$50,000 net are cartoned. Cartoned shipments are packaged with cardboard channels and shrink wrap.

Geiger seating is cartoned in boxes for all shipments. Blanket wrapping is available upon request.

If Customer requests special shipping or delivery methods, Customer is responsible for any extra costs that result.

#### Packaging and Shipping (continued)

Customer obtains title to products and materials and assumes the risk of loss for them upon shipment from Geiger's plant. Geiger reserves the right to make partial shipments, of truckload quantities, as products are manufactured.

#### Shipping Surcharge

A shipping surcharge will be added to all orders under \$100,000 list based on the ship-to address. The surcharge is a percentage of the total list price of the entire order, calculated on the base price only. Upcharges for veneer, edges, textiles, pulls, etc., are not counted in the calculation.

Zone 1	3.0%	(GA, NC, SC)
Zone 2	3.5%	(AL, FL, MS, TN, AR, LA)
Zone 3	4.0%	(IL, IN, KY, MI, OH, WI, IA, KS, MN, MO, ND, NE, SD, DC, MD, VA)
Zone 4	4.5%	(CT, MA, ME, NH, RI, VT, DE, NJ, NY, PA, WV)
Zone 5	5.0%	(OK, TX, AZ, NM, NV, UT, CO)
Zone 6	5.5%	(OR, WA, ID, MT WY, CA, Canada)

#### International Shipping

Orders for export are shipped Ex Works factory (Incoterms 2000). The charge for export packing is five percent of the net order value. There are no export packing charges on shipments to Canada.

#### Claims

All blanket wrapped shipments must be unwrapped and inspected at the dock, in the presence of the driver. Claims for "concealed damage" or "subject to inspection" will not be honored on blanket wrapped shipments. All cartoned shipments must be inspected for visual outside damage to the package.

Damages and piece count shortages must be noted on the bill of lading. Freight claims must be filed within 30 days (including cartoned shipments with concealed damage). Contact Customer Care for a warranty/freight claim form and send it by fax, mail or email to:

Geiger International  
6095 Fulton Industrial Blvd., SW  
Atlanta, GA 30336-2806  
Attention: Warranty Department  
Fax: 1.404.836.7519

#### Order Information

Herman Miller dealers must submit all purchase orders to Geiger via Omni. For assistance with this process, please contact Herman Miller Sales Technology Support at 800.833.3330.

All Geiger Gallery and non-Herman Miller dealers may submit their orders via email or fax at 404.836.7519. For assistance with this

#### Order Information (continued)

process, please contact Geiger Customer Care at 800.456.6452.

Midwest	custcaremw@geigerfurniture.com
New York	custcareny@geigerfurniture.com
Northeast	custcarene@geigerfurniture.com
South	custcaresouth@geigerfurniture.com
West	custcarewest@geigerfurniture.com
Int'l	custcareintl@geigerfurniture.com

#### Warranty

Geiger International, Inc. ("Geiger"), 6095 Fulton Industrial Blvd., SW, Atlanta, GA 30336-2806, USA, warrants the products sold by it to be free from defects in material and workmanship, regardless of the number of shifts during which the products are used, for the warranty periods specified below.

This warranty covers the sale of Geiger product in all countries. Not all of the product lines appearing on this list are marketed by Geiger in all countries, and appearance on this list does not imply an offer for sale of a product line in a particular place. Product line availability is defined in current price lists applicable to different regions.

#### Geiger Commercial Office Furniture Products 12 years

All products sold under the Geiger® brand name, except as limited or described below.

#### Textiles and Leathers 3 years

Includes, but is not limited to Edelman Leather, Geiger, Herman Miller, Maharam, and Place fabrics.

#### Nonstandard Products 1 to 5 years

Warranty length on nonstandard products not covered by the 12-year warranty is identified on individual product quotes.

#### All Other Products, Parts, and Services 2 years

Height adjustable bases (electrical parts)

#### 5 years

Height adjustable bases (mechanical parts)  
Task light electronic ballasts

#### 3 years

All service parts

#### 6 months

All other products, parts, and any services not listed above, sold or furnished by Geiger, except for consumable products such as light bulbs and other electronic products for which no warranty is given

#### Warranty (continued)

#### Other Manufacturers' Products

##### None

Geiger will pass through to the original purchaser any warranty supplied by other manufacturers to the extent possible, including, but not limited to, open-line laminates.

#### Provisions that apply to all products and services:

During the applicable warranty period, Geiger, as its sole obligation, will repair or replace (at its option) any product, part, or component covered by this warranty and sold after the effective date of this warranty, which fails under normal use as a result of a defect in material or workmanship; Geiger will repair or replace the aforementioned product, part, or component with a comparable product, part, or component.

This warranty extends only to the original purchasers who acquire new product from Geiger, or its authorized resellers. Any product, part, or component must have been installed, used, and maintained according to Geiger's published instructions in order to be eligible for coverage under this warranty and must not have been subject to misuse or abuse. Any modification to the original product voids the warranty. Geiger does not warrant the performance of the product when used in combination with other than original Geiger product.

The warranty period starts from the date of purchase.

This document inclusively describes all of the warranties given and remedies available with respect to the company's products and services. Geiger disclaims any other warranty whether express or implied, statutory or otherwise, in relation to the products.

Geiger does not warrant:

- natural variations in wood grain or figure or the presence of character marks
- changes in surface finishes due to aging or exposure to light
- marks, scars, or wrinkles occurring naturally in leather
- veins, marks, voids, fissures, or cracks found naturally in stone

In addition, Geiger does not warrant:

- failure resulting from normal wear and tear
- the matching of colors, grains, or textures of natural materials
- the colorfastness or the matching of colors of textiles, including an exact match to cuttings or to swatch cards
- damage, marking, or staining of veneer surfaces due to contact with rubber or similar compounds; damage from sharp objects or imprinting from writing instruments, or prolonged exposure to direct sunlight

#### Warranty (continued)

Geiger tests Customer's Own Material (COM) and other customer-supplied items for manufacturing quality only and does not provide any warranty with regard to these materials.

Geiger does not warrant products that are exposed to extreme environmental conditions or that have been subject to improper storage.

Geiger's products meet the requirements of national and specific local codes as stated in the price books and other written publications.

**TO THE EXTENT ALLOWED BY LAW, ANY IMPLIED WARRANTIES, INCLUDING ANY WARRANTY OF MERCHANTABILITY OR FITNESS FOR A PARTICULAR PURPOSE, ARE DISCLAIMED AND TO THE EXTENT THEY ARE LEGALLY REQUIRED, ARE LIMITED IN DURATION TO THE DURATION OF THIS WRITTEN WARRANTY.**

**GEIGER SHALL NOT BE LIABLE FOR LOSS OF TIME, INCONVENIENCE, COMMERCIAL LOSS, OR INCIDENTAL OR CONSEQUENTIAL DAMAGES.**

Applies in US only: Some states do not allow limitations on how long an implied warranty lasts or do not allow the exclusion or limitation of incidental or consequential damages, so the limitations or exclusions in the two preceding paragraphs may not apply. This warranty gives the purchaser specific legal rights; however, the purchaser may also have other rights that may vary from state to state.

Applies outside US: Except as stated above, Geiger will not be liable for any loss or damage (including costs) however caused, whether direct or consequential, incurred or suffered by the purchaser or any third party in respect of the products but nothing contained herein will or will be considered to exclude or restrict any liability on Geiger's part for death or personal injury resulting from negligence.

#### Limitations and Disclaimers

Geiger is not liable for loss of time, inconvenience, lost profits, commercial loss, or other special, consequential, or incidental damages for any transaction.

Geiger reserves the right to change its designs, its methods of construction, or its prices, charges, or policies at any time without notice to Customer.

#### Design Rights

The designs depicted in Geiger's catalogs and price lists are proprietary to Geiger and Geiger reserves the exclusive right to manufacture them. Any reproduction of these designs infringes Geiger's rights and that infringement will be prosecuted.

### How to Specify

- For each product ordered, specify a product number string. The string should include the product number and all finish and detail codes listed at the bottom of the pricebook page under "Specify".
- Specify the finishes and details in the same sequence shown on the pricebook page.
- Product Number String Example:  
IWCS2U-185926 946 CHR CHR

The product number string above includes all codes required for a Domino Credenza, Shelf Storage, Two Units Wide, Uniform Exterior and Interior Veneers. 17-3/4"D x 59"W x 26"H with the following specifications:

Product Number ..... IWCS2U-185926  
Wood Finish..... 946 Cocoa Cherry  
Base Finish..... CHR Chrome  
Pulls..... CHR Chrome

### General Notes

- All dimensions shown are nominal, and fractional dimensions are rounded to the nearest half inch.

### Base Finishes

#### Standard Base Finishes

*For credenzas and sideboards*

CHR.....Chrome

SAC .....Satin Chrome

### Pull Finishes

#### Standard Pull Finishes

*For credenzas and sideboards*

CHR.....Chrome

SAC .....Satin Chrome

#### Standard Base Finishes

*For tables and desks*

BK.....Matte Black

CHR.....Chrome

SAC .....Satin Chrome



Code	Description	Leather Color	Drawer Solid
662	Toasted Walnut, Matte	Tenera Dark Chocolate (17510)	Walnut
663	Charred Walnut, Matte	Tenera Dark Chocolate (17510)	Walnut
664	Bronzed Walnut, Matte	Tenera Dark Chocolate (17510)	Walnut
665	Smoked Walnut, Matte	Tenera Cement (17501)	Ash
666	Coffee Walnut, Matte	Tenera Dark Chocolate (17510)	Walnut
667	Smoked Paldao, Matte	Tenera Cement (17501)	Ash
668	Figured Sycamore, Matte	Tenera Sunglow (17503)	Ash
669	Warm Paldao, Matte	Tenera Dark Chocolate (17510)	Walnut
677	Chocolate Ash, Matte	Tenera Dark Chocolate (17510)	Walnut
678	Natural Oak, Matte	Tenera Sunglow (17503)	Ash
68R	Recograin Rosewood, Matte	Tenera Dark Chocolate (17510)	Walnut
68W	Recograin Walnut, Matte	Tenera Dark Chocolate (17510)	Walnut
69A	Recograin Frosty Ash, Matte	Tenera Cement (17501)	Ash
69G	Recograin Wenge, Matte	Tenera Dark Chocolate (17510)	Walnut
69K	Recograin Oak, Matte	Tenera Sunglow (17503)	Ash
69R	Recograin Rosewood, Matte	Tenera Dark Chocolate (17510)	Walnut
69T	Recograin Teak, Matte	Tenera Dark Chocolate (17510)	Walnut
69W	Recograin Walnut, Matte	Tenera Dark Chocolate (17510)	Walnut
6A1	White Ash, Matte	Tenera Sunglow (17503)	Ash
6K1	Rift Oak, Matte, Rift-Cut,	Tenera Sunglow (17503)	Ash
6K6	Burnt Oak, Matte, Rift-Cut,	Tenera Black (17511)	Walnut
911	Champagne Maple, Low Sheen	Tenera Sunglow (17503)	Ash
941	Natural Beech, Low Sheen	Tenera Sunglow (17503)	Ash
942	Sundance Cherry, Low Sheen	Tenera Dark Chocolate (17510)	Walnut
943	Caramel Cherry, Low Sheen	Tenera Dark Chocolate (17510)	Walnut
946	Cocoa Cherry, Low Sheen	Tenera Dark Chocolate (17510)	Walnut
951	Natural Anigre, Low Sheen	Tenera Sunglow (17503)	Ash
956	Cocoa Sapele, Low Sheen	Tenera Dark Chocolate (17510)	Walnut
962	Toasted Walnut, Low Sheen	Tenera Dark Chocolate (17510)	Walnut
963	Charred Walnut, Low Sheen	Tenera Dark Chocolate (17510)	Walnut
964	Bronzed Walnut, Low Sheen	Tenera Dark Chocolate (17510)	Walnut
965	Smoked Walnut, Low Sheen	Tenera Cement (17501)	Ash
966	Coffee Walnut, Low Sheen	Tenera Dark Chocolate (17510)	Walnut
967	Smoked Paldao, Low Sheen	Tenera Cement (17501)	Ash
968	Figured Sycamore, Low Sheen	Tenera Sunglow (17503)	Ash
969	Warm Paldao, Low Sheen	Tenera Dark Chocolate (17510)	Walnut
977	Chocolate Ash, Low Sheen	Tenera Dark Chocolate (17510)	Walnut
978	Natural Oak, Low Sheen	Tenera Sunglow (17503)	Ash
981	Champagne Hickory, Low Sheen	Tenera Sunglow (17503)	Ash
991	Champagne Ash, Low Sheen	Tenera Sunglow (17503)	Ash
998	Ebony Ash, Low Sheen	Tenera Black (17511)	Walnut
98R	Recograin Rosewood, Low Sheen	Tenera Dark Chocolate (17510)	Walnut
98W	Recograin Walnut, Low Sheen	Tenera Dark Chocolate (17510)	Walnut
99A	Recograin Frosty Ash, Low Sheen	Tenera Cement (17501)	Ash
99G	Recograin Wenge, Low Sheen	Tenera Dark Chocolate (17510)	Walnut
99K	Recograin Oak, Low Sheen	Tenera Sunglow (17503)	Ash
99R	Recograin Rosewood, Low Sheen	Tenera Dark Chocolate (17510)	Walnut

Code	Description	Leather Color	Drawer Solid
99T	Recograin Teak, Low Sheen	Tenera Dark Chocolate (17510)	Walnut
99W	Recograin Walnut, Low Sheen	Tenera Dark Chocolate (17510)	Walnut
9A1	White Ash, Low Sheen	Tenera Sunglow (17503)	Ash
9K1	Rift Oak, Low Sheen, Rift-Cut,	Tenera Sunglow (17503)	Ash
9K6	Burnt Oak, Low Sheen, Rift-Cut,	Tenera Black (17511)	Walnut
9N	Santos Palisander, Matte	Tenera Dark Chocolate (17510)	Walnut
DAE	Ebony Exterior, Ash Int., Matte	Tenera Sunglow (17503)	Ash
DAR	Morado Exterior, Ash Int., Matte	Tenera Sunglow (17503)	Ash
DAW	Walnut Exterior, Ash Int., Matte	Tenera Sunglow (17503)	Ash
DCE	Ebony Exterior, Coffee Walnut Int., Matte	Tenera Dark Chocolate (17510)	Walnut
DCL	Morado Exterior, Coffee Walnut Int., Matte	Tenera Dark Chocolate (17510)	Walnut
DCW	Walnut Exterior, Coffee Walnut Int., Matte	Tenera Dark Chocolate (17510)	Walnut
DAL	Black Limba Exterior, Ash Int., Matte	Tenera Sunglow (17503)	Ash
DCL	Black Limba Exterior, Coffee Walnut Int., Matte	Tenera Dark Chocolate (17510)	Walnut
DBL	Black Limba Exterior, Ebonized Ash Int, Matte	Tenera Black (17511)	Ash
DAS	Recograin Rosewood Exterior, Ash Int., Matte	Tenera Sunglow (17503)	Ash
DCS	Recograin Rosewood Exterior, Coffee Walnut Int., Matte	Tenera Dark Chocolate (17510)	Walnut
ED	Aged Cherry, Low Sheen	Tenera Dark Chocolate (17510)	Walnut
EK	Medium Red Walnut, Low Sheen	Tenera Dark Chocolate (17510)	Walnut
ET	Recograin Natural Ash	Tenera Sunglow (17503)	Ash
EU	Recograin Oak	Tenera Sunglow (17503)	Ash
EV	Recograin Walnut	Tenera Dark Chocolate (17510)	Walnut
G2U	Light Brown Walnut, Low Sheen	Tenera Dark Chocolate (17510)	Walnut
G40	Dark Brown Walnut, Low Sheen	Tenera Dark Chocolate (17510)	Walnut
GOU	Walnut, Matte	Tenera Dark Chocolate (17510)	Walnut
UX	Walnut On Cherry, Low Sheen	Tenera Dark Chocolate (17510)	Walnut

Wood Finishes						
Code	Description	Sideboards and Credenzas		Tables	Desks	
		Uniform Veneer	Contrasting Veneer		Uniform Veneer	Contrasting Veneer
662	Toasted Walnut, Matte, Flat-Cut, Book-Matched	•		•	•	
663	Charred Walnut, Matte, Flat-Cut, Book-Matched	•		•	•	
664	Bronzed Walnut, Matte, Flat-Cut, Book-Matched	•		•	•	
665	Smoked Walnut, Matte, Flat-Cut, Book-Matched	•		•	•	
666	Coffee Walnut, Matte, Flat-Cut, Book-Matched	•		•	•	
667	Smoked Paldao, Matte, Qtr-Cut, Slip-Matched	+5%		+5%	+5%	
668	Figured Sycamore, Matte, Qtr-Cut, Slip-Matched	+8%		+8%	+8%	
669	Warm Paldao, Matte, Qtr-Cut, Slip-Matched	+5%		+5%	+5%	
677	Chocolate Ash, Matte, Flat-Cut, Book-Matched	•		•	•	
678	Natural Oak, Matte, Flat-Cut, Book-Matched	•		•	•	
68R	RecoGrain Rosewood, Matte, Flat-Cut, Slip-Matched	•		•	•	
68W	RecoGrain Walnut, Matte, Flat-Cut, Slip-Matched	•		•	•	
69A	RecoGrain Frosty Ash, Matte, Qtr-Cut, Slip-Matched	•		•	•	
69G	RecoGrain Wenge, Matte, Qtr-Cut, Slip-Matched	•		•	•	
69K	RecoGrain Oak, Matte, Qtr-Cut, Slip-Matched	•		•	•	
69R	RecoGrain Rosewood, Matte, Qtr-Cut, Slip-Matched	•		•	•	
69T	RecoGrain Teak, Matte, Qtr-Cut, Slip-Matched	•		•	•	
69W	RecoGrain Walnut, Matte, Qtr-Cut, Slip-Matched	•		•	•	
6A1	White Ash, Matte, Qtr-Cut, Slip-Matched	•		•	•	
6K1	Rift Oak, Matte, Rift-Cut, Slip-Matched	•		•	•	
6K6	Burnt Oak, Matte, Rift-Cut, Slip-Matched	•		•	•	
911	Champagne Maple, Low Sheen, Flat-Cut, Book-Matched	•		•	•	
941	Natural Beech, Low Sheen, Flat-Cut, Book-Matched	•		•	•	
942	Sundance Cherry, Low Sheen, Flat-Cut, Book-Matched	•		•	•	
943	Caramel Cherry, Low Sheen, Flat-Cut, Book-Matched	•		•	•	
946	Cocoa Cherry, Low Sheen, Flat-Cut, Book-Matched	•		•	•	
951	Natural Anigre, Low Sheen, Qtr-Cut, Slip-Matched	•		•	•	
956	Cocoa Sapele, Low Sheen, Qtr-Cut, Slip-Matched	•		•	•	
962	Toasted Walnut, Low Sheen, Flat-Cut, Book-Matched	•		•	•	
963	Charred Walnut, Low Sheen, Flat-Cut, Book-Matched	•		•	•	
964	Bronzed Walnut, Low Sheen, Flat-Cut, Book-Matched	•		•	•	
965	Smoked Walnut, Low Sheen, Flat-Cut, Book-Matched	•		•	•	
966	Coffee Walnut, Low Sheen, Flat-Cut, Book-Matched	•		•	•	
967	Smoked Paldao, Low Sheen, Qtr-Cut, Slip-Matched	+5%		+5%	+5%	
968	Figured Sycamore, Low Sheen, Qtr-Cut, Slip-Matched	+8%		+8%	+8%	
969	Warm Paldao, Low Sheen, Qtr-Cut, Slip-Matched	+5%		+5%	+5%	
977	Chocolate Ash, Low Sheen, Flat-Cut, Book-Matched	•		•	•	
978	Natural Oak, Low Sheen, Flat-Cut, Book-Matched	•		•	•	
981	Champagne Hickory, Low Sheen, Flat-Cut, Book-Matched	•		•	•	
991	Champagne Ash, Low Sheen, Flat-Cut, Book-Matched	•		•	•	
998	Ebony Ash, Low Sheen, Flat-Cut, Book-Matched	•		•	•	
98R	RecoGrain Rosewood, Low Sheen, Flat-Cut, Slip-Matched	•		•	•	



Wood Finishes						
Code	Description	Sideboards and Credenzas		Tables	Desks	
		Uniform Veneer	Contrasting Veneer		Uniform Veneer	Contrasting Veneer
98W	RecoGrain Walnut, Low Sheen, Flat-Cut, Slip-Matched	•		•	•	
99A	RecoGrain Frosty Ash, Low Sheen, Qtr-Cut, Slip-Matched	•		•	•	
99G	RecoGrain Wenge, Low Sheen, Qtr-Cut, Slip-Matched	•		•	•	
99K	RecoGrain Oak, Low Sheen, Qtr-Cut, Slip-Matched	•		•	•	
99R	RecoGrain Rosewood, Low Sheen, Qtr-Cut, Slip-Matched	•		•	•	
99T	RecoGrain Teak, Low Sheen, Qtr-Cut, Slip-Matched	•		•	•	
99W	RecoGrain Walnut, Low Sheen, Qtr-Cut, Slip-Matched	•		•	•	
9A1	White Ash, Low Sheen, Qtr-Cut, Slip-Matched	•		•	•	
9K1	Rift Oak, Low Sheen, Rift-Cut, Slip-Matched	•		•	•	
9K6	Burnt Oak, Low Sheen, Rift-Cut, Slip-Matched	•		•	•	
9N	Santos Palisander, Matte, Flat-Cut, Book-Matched	+10%		+10%		
BT7	Black Limba, Matte Sheen, Qtr-Cut			+6%		
DAE	Ebony Exterior, Ash Int., Matte, Flat-Cut, Book-Matched		•			•
DAL	Black Limba, Matte Sheen, Qtr-Cut					•
DAR	Morado Exterior, Ash Int., Matte, Flat-Cut, Book-Matched		•			•
DAS	RecoGrain Rosewood Exterior, Ash Interior, Matte					•
DAW	Walnut Exterior, Ash Int., Matte, Flat-Cut, Book-Matched		•			•
DBL	Black Limba Exterior, Black Ash Interior, Matte					•
DCE	Ebony Exterior, Coffee Walnut Interior, Matte					•
DCL	Black Limba Exterior, Coffee Walnut Interior, Matte					•
DCR	Morado Exterior, Coffee Walnut Interior, Matte					•
DCS	RecoGrain Rosewood Exterior, Coffee Walnut Interior, Matte					•
DCW	Walnut Exterior, Coffee Walnut Interior, Matte					•
ED	Aged Cherry, Low Sheen, Flat-Cut, Book-Matched	•		•	•	
EK	Medium Red Walnut, Low Sheen, Flat-Cut, Book-Matched	•		•	•	
ET	RecoGrain Natural Ash, Matte, Qtr-Cut, Slip-Matched	•		•	•	
EU	RecoGrain Oak, Matte, Qtr-Cut, Slip-Matched	•		•	•	
EV	RecoGrain Walnut, Matte, Qtr-Cut, Slip-Matched	•		•	•	
G2U	Light Brown Walnut, Low Sheen, Flat-Cut, Book-Matched	•		•	•	
G40	Dark Brown Walnut, Low Sheen, Flat-Cut, Book-Matched	•		•	•	
GOU	Walnut, Matte, Flat-Cut, Book-Matched	•		•	•	
Q13	Ebony, Matte Sheen, Flat Cut			+10%		
Q14	Morado, Matte Sheen, Flat Cut			+9%		
Q15	Natural Walnut, Matte Sheen, Flat Cut			•		
UX	Walnut On Cherry, Low Sheen, Flat-Cut, Book-Matched	•		•	•	

### Notes

- Interior finish on contrasting veneered units is quarter-cut natural ash.
- Special finish colors may be developed for uniform veneered credenzas on orders over \$200,000 list upon request at no additional charge. A one-time set-up fee of \$250 net will be charged on orders under \$200,000 list for each special finish. Special finish colors are not available on contrasting veneered units. In order to protect the quality and durability of Geiger's finish, the chemical composition of the staining materials, water-base sealers, and urethane top coats will not be altered for special finishes.
- Exotic veneers such as pearwood, bird's eye maple and sycamore are available upon request for uniform veneered credenzas, at additional cost. Exotic veneers are not available on contrasting veneered units.
- For further information and procedures for special finishes or exotic veneers, contact your Geiger sales representative.

	Product Number	Depth	Width	Height	Base Price
Table • Round	<b>IWT1-36</b>	36	36	30	\$4,368
	<b>IWT1-48</b>	48	48	30	\$5,351

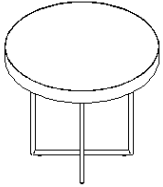

**Specify**

Wood  
 Base

Table top thickness is 3-1/2" with veneered edge.  
 Base is 1" diameter steel tubing.  
 Top and base ship separately.  
 Includes 3/4" levelers

	Product Number	Depth	Width	Height	Base Price
Desk • No Storage	<b>IWDSN-3072</b>	30	72	30	\$7,754
	<b>IWDSN-3684</b>	36	84	30	\$9,392

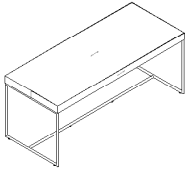

### Specify

Wood  
 Base

Table top thickness is 3-1/2" with veneered edge.  
 Base is 1" diameter steel tubing.  
 Top and base ship separately.  
 Includes 3/4" levelers

	Product Number	Depth	Width	Height	Base Price
Desk • With Storage	<i>storage on left, uniform veneer</i>				
	<b>IWDSL-3072</b>	30	72	30	\$12,886
	<b>IWDSL-3684</b>	36	84	30	\$14,524
	<i>storage on right, uniform veneer</i>				
	<b>IWDSR-3072</b>	30	72	30	\$12,886
	<b>IWDSR-3684</b>	36	84	30	\$14,524
	<i>storage on left, contrasting veneer</i>				
	<b>IWDSL-3072</b>	30	72	30	\$13,104
	<b>IWDSL-3684</b>	36	84	30	\$14,742
	<i>storage on right, contrasting veneer</i>				
	<b>IWDSR-3072</b>	30	72	30	\$13,104
	<b>IWDSR-3684</b>	36	84	30	\$14,742

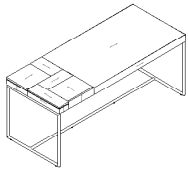

shown with storage on left

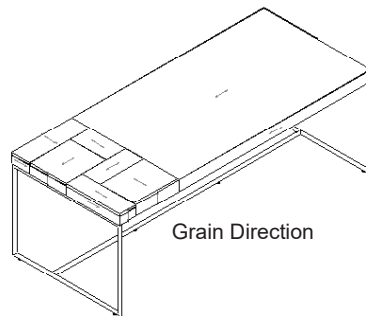

Grain Direction

### Drawer Dimensions

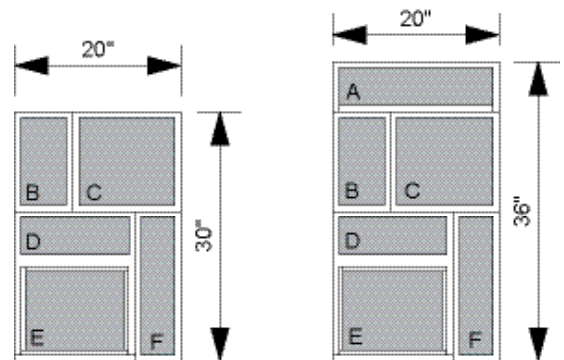

- A 4 1/2" x 18 1/2"
- B 10 1/2" x 5 1/2"
- C 10 1/2" x 11 1/2"
- D 4 1/2" x 13"
- E 9 1/2" x 11 7/8"
- F 16 1/2" x 4"A

### Specify

Wood Desk 30" deep includes one drawer and four storage compartments with push-to-open lids.  
 Base Desk 36" deep includes one drawer and five storage compartments with push-to-open lids.  
 Desk top thickness is 3-1/2" with veneered edge.  
 Base is 1" diameter steel tubing and includes 3/4" high leveler.  
 Drawer includes routed finger groove on underside of drawer front.  
 Top, storage section, and base ship separately.  
 Drawer boxes have a Tenara leather lining on the bottom. Leather color is determined by the wood finish specified.  
 Drawer boxes are ash or walnut. Drawer material is determined by the wood finish specified.

	Product Number	Depth	Width	Height	Base Price
Credenza • Shelf Storage <i>two units wide</i>	<i>uniform veneer</i> <b>IWCS2U-185926</b>	17 3/4	59	26	\$5,738
	<i>contrasting veneer</i> <b>IWCS2C-185926</b>	17 3/4	59	26	\$5,826

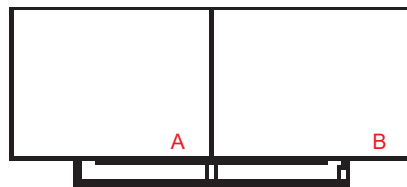
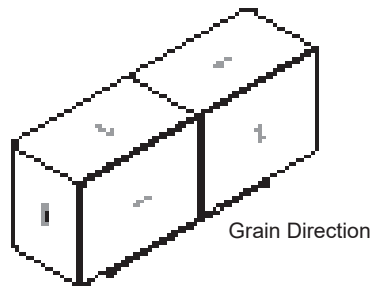
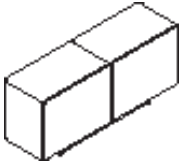

- A Shelf with Door Hinged Left, Attaches Right  
29 1/2W x 22H (inside clearance 16 1/4D x 28W x 20 1/2H)
- B Shelf with Door Hinged Right, Attaches Left  
29 1/2W x 22H (inside clearance 16 1/4D x 28W x 20 1/2H)

### Specify

Wood Units with uniform veneer are provided with the same veneer and finish on the interior and exterior.

Base Units with contrasting veneer are provided with natural ash veneer on the interior and the specified veneer on the exterior.

Pull Grain direction on the interior of units matches the grain direction on the exterior.

Drawer boxes and waste bins for all units are quarter-cut natural ash with a hand-rubbed tung-oil finish

	Product Number	Depth	Width	Height	Base Price
--	----------------	-------	-------	--------	------------

Credenza • Shelf Storage  
three units wide

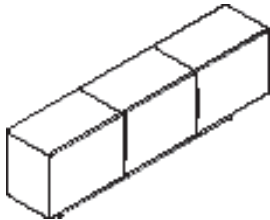

*uniform veneer*  
**IWCS3U-188926**      17 3/4    88 1/2    26      \$8,603

*contrasting veneer*  
**IWCS3C-188926**      17 3/4    88 1/2    26      \$8,734

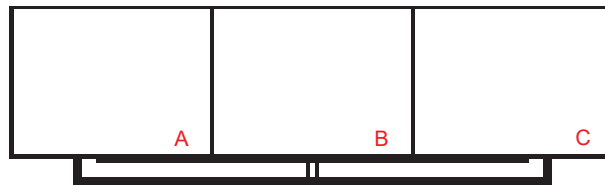
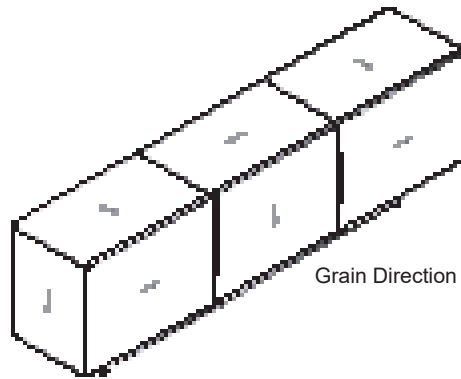

- A      Shelf with Door Hinged Left, Attaches Right  
29 1/2W x 22H (inside clearance 16 1/4D x 28W x 20 1/2H)
- B      Shelf with Door Hinged Right, Attaches Left and Right  
29 1/2W x 22H (inside clearance 16 1/4D x 28W x 20 1/2H)
- C      Shelf with Door Hinged Right, Attaches Left  
29 1/2W x 22H (inside clearance 16 1/4D x 28W x 20 1/2H)

### Specify

**Wood**      Units with uniform veneer are provided with the same veneer and finish on the interior and exterior.

**Base**      Units with contrasting veneer are provided with natural ash veneer on the interior and the specified veneer on the exterior.

**Pull**      Grain direction on the interior of units matches the grain direction on the exterior.  
Drawer boxes and waste bins for all units are quarter-cut natural ash with a hand-rubbed tung-oil finish

	Product Number	Depth	Width	Height	Base Price
--	----------------	-------	-------	--------	------------

Credenza • Shelf Storage  
four units wide

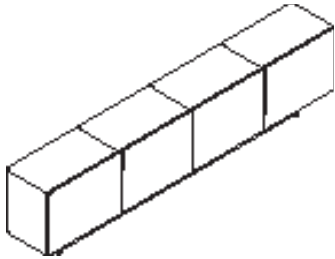

*uniform veneer*  
**IWCS4U-1811826**      17 3/4   118 1/8   26      \$11,469

*contrasting veneer*  
**IWCS4C-1811826**      17 3/4   118 1/8   26      \$11,646

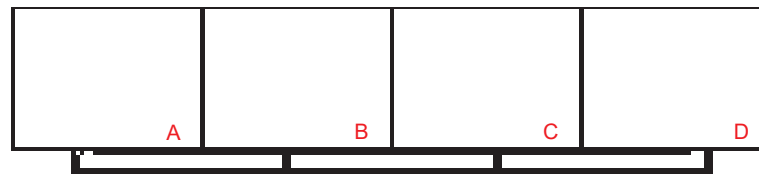
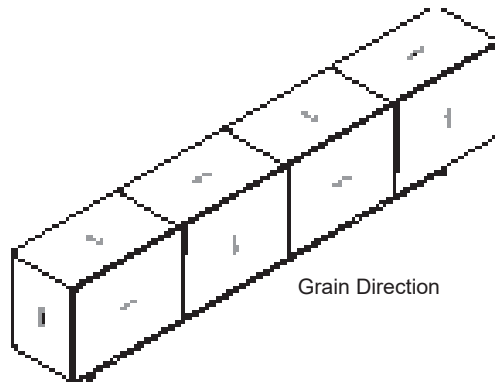

- A Shelf with Door Hinged Left, Attaches Right  
29 1/2W x 22H (inside clearance 16 1/4D x 28W x 20 1/2H)
- B Shelf with Door Hinged Right, Attaches Left and Right  
29 1/2W x 22H (inside clearance 16 1/4D x 28W x 20 1/2H)
- C Shelf with Door Hinged Left, Attaches Left and Right  
29 1/2W x 22H (inside clearance 16 1/4D x 28W x 20 1/2H)
- D Shelf with Door Hinged Right, Attaches Left  
29 1/2W x 22H (inside clearance 16 1/4D x 28W x 20 1/2H)

**Specify**

Wood Units with uniform veneer are provided with the same veneer and finish on the interior and exterior.  
 Base Units with contrasting veneer are provided with natural ash veneer on the interior and the specified veneer on the exterior.  
 Pull Grain direction on the interior of units matches the grain direction on the exterior.  
 Drawer boxes and waste bins for all units are quarter-cut natural ash with a hand-rubbed tung-oil finish

	Product Number	Depth	Width	Height	Base Price
--	----------------	-------	-------	--------	------------

Credenza • Mixed Storage  
two units wide

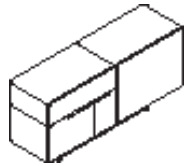

*uniform veneer*  
**IWCM2U-185926**      17 3/4      59      26      \$12,396

*contrasting veneer*  
**IWCM2C-185926**      17 3/4      59      26      \$12,553

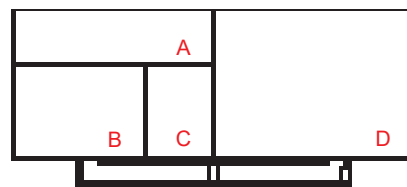
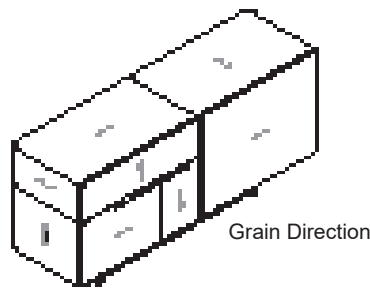

- A      Box Drawer, Attachment Holes Right  
29 1/2W x 8 1/4H
- B      File Drawer, Attachment Holes Right and Top  
19 5/8W x 13 3/4H
- C      Waste Drawer With Removable Waste Bin  
Attachment Holes Left, Right and Top  
9 7/8W x 13 3/4H
- D      Shelf with Door Hinged Right, Attaches Left  
29 1/2W x 22H (inside clearance 16 1/4D x 28W x 20 1/2H)

**Specify**

Wood      Units with uniform veneer are provided with the same veneer and finish on the interior and exterior.  
Base      Units with contrasting veneer are provided with natural ash veneer on the interior and the specified veneer on the exterior.  
Pull      Grain direction on the interior of units matches the grain direction on the exterior.  
Drawer boxes and waste bins for all units are quarter-cut natural ash with a hand-rubbed tung-oil finish



	Product Number	Depth	Width	Height	Base Price
--	----------------	-------	-------	--------	------------

Credenza • Mixed Storage  
three units wide

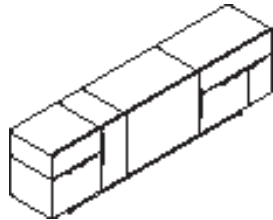

*uniform veneer*  
**IWCM3U-188926**      17 3/4    88 1/2    26      \$21,541

*contrasting veneer*  
**IWCM3C-188926**      17 3/4    88 1/2    26      \$21,816

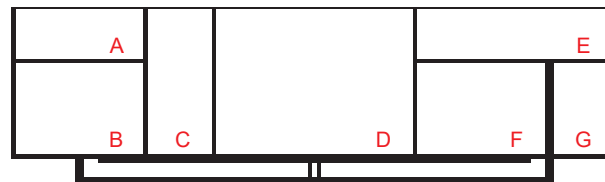
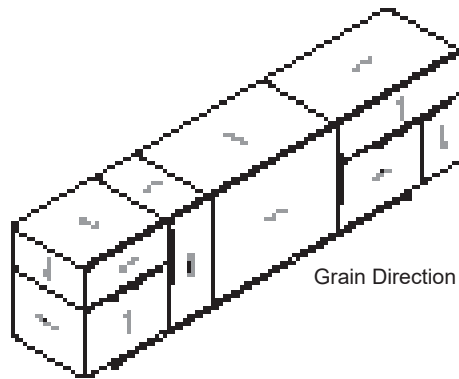

- A      Box Drawer, With Insert Boxes, Attachment Holes Right  
13 3/4W x 8 1/4H
- B      File Drawer, Attachment Holes, Right and Top  
19 5/8W x 13 3/4H
- C      Tower with Door Hinged Right, Attachment Holes Left and Right  
9 7/8W x 22H
- D      Shelf with Door Hinged Left, Attaches Left and Right  
29 1/2W x 22H (inside clearance 16 1/4D x 28W x 20 1/2H)
- E      Box Drawer, Attachment Holes Left  
29 1/2W x 8 1/4H
- F      File Drawer, Attachment Holes, Left, Right and Top  
19 5/8W x 13 3/4H
- G      Waste Drawer With Removable Waste Bin, Attachment Holes Left and Top  
9 7/8W x 13 3/4H

**Specify**

Wood      Units with uniform veneer are provided with the same veneer and finish on the interior and exterior.  
Base      Units with contrasting veneer are provided with natural ash veneer on the interior and the specified veneer on the exterior.  
Pull      Grain direction on the interior of units matches the grain direction on the exterior.  
Drawer boxes and waste bins for all units are quarter-cut natural ash with a hand-rubbed tung-oil finish

	Product Number	Depth	Width	Height	Base Price
--	----------------	-------	-------	--------	------------

Credenza • Mixed Storage  
four units wide

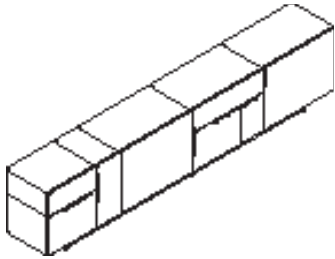

*uniform veneer*  
**IWCM4U-1811826**      17 3/4   118 1/8   26      \$24,407

*contrasting veneer*  
**IWCM4C-1811826**      17 3/4   118 1/8   26      \$24,726

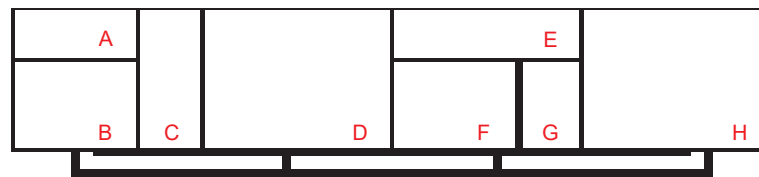
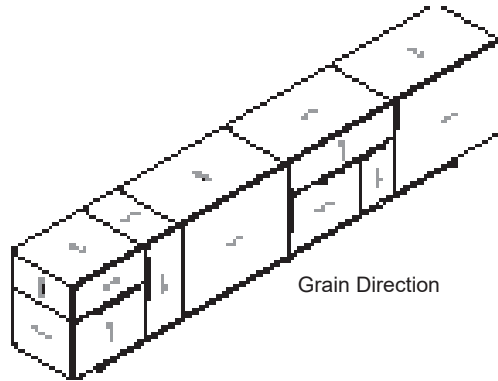

- A      Box Drawer, With Insert Boxes, Attachment Holes Right  
19 5/8W x 8 1/4H
- B      File Drawer, Attachment Holes, Right and Top  
19 5/8W x 13 3/4H
- C      Tower with Door Hinged Right, Attachment Holes Left and Right  
9 7/8W x 22H
- D      Shelf with Door Hinged Left, Attaches Left and Right  
29 1/2W x 22H (inside clearance 16 1/4D x 28W x 20 1/2H)
- E      Box Drawer, Attachment Holes Left and Right  
29 1/2W x 8 1/4H
- F      File Drawer, Attachment Holes, Left, Right and Top  
19 5/8W x 13 3/4H
- G      Waste Drawer With Removable Waste Bin, Attachment Holes Left, Right and Top  
9 7/8W x 13 3/4H
- H      Shelf with Door Hinged Right, Attaches Left  
29 1/2W x 22H (inside clearance 16 1/4D x 28W x 20 1/2H)

**Specify**

Wood      Units with uniform veneer are provided with the same veneer and finish on the interior and exterior.  
Base      Units with contrasting veneer are provided with natural ash veneer on the interior and the specified veneer on the exterior.  
Pull      Grain direction on the interior of units matches the grain direction on the exterior.  
Drawer boxes and waste bins for all units are quarter-cut natural ash with a hand-rubbed tung-oil finish

	Product Number	Depth	Width	Height	Base Price
--	----------------	-------	-------	--------	------------

Sideboard • Shelf Storage  
two units wide

*uniform veneer*  
**IWSS2U-185940**      17 3/4      59      39 3/4      \$6,989

*contrasting veneer*  
**IWSS2C-185940**      17 3/4      59      39 3/4      \$7,077

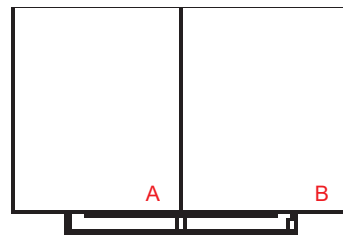
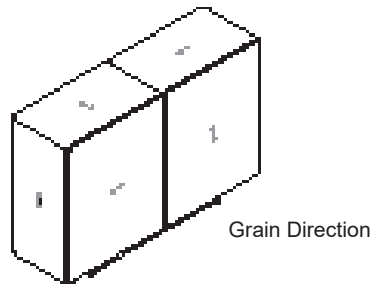
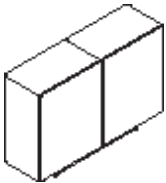

- A      2 Shelves with Door Hinged Left, Attaches Right  
29 1/2W x 35 7/8H (inside clearance 16 1/4D x 28W x 34 3/8H)
- B      2 Shelves with Door Hinged Right, Attaches Left  
29 1/2W x 35 7/8H (inside clearance 16 1/4D x 28W x 34 3/8H)

### Specify

**Wood**      Units with uniform veneer are provided with the same veneer and finish on the interior and exterior.

**Base**      Units with contrasting veneer are provided with natural ash veneer on the interior and the specified veneer on the exterior.

**Pull**      Grain direction on the interior of units matches the grain direction on the exterior.  
Drawer boxes and waste bins for all units are quarter-cut natural ash with a hand-rubbed tung-oil finish

	Product Number	Depth	Width	Height	Base Price
--	----------------	-------	-------	--------	------------

Sideboard • Shelf Storage  
three units wide

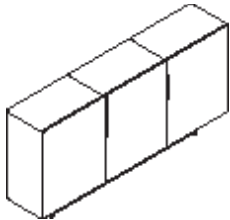

*uniform veneer*  
**IWSS3U-188940**      17 3/4    88 1/2    39 3/4      \$10,481

*contrasting veneer*  
**IWSS3C-188940**      17 3/4    88 1/2    39 3/4      \$10,614

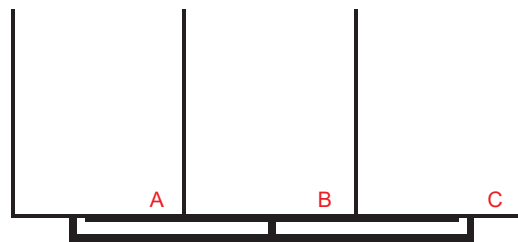
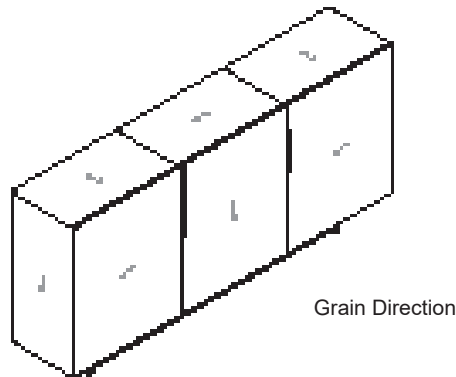

- A      2 Shelves with Door Hinged Left, Attaches Right  
29 1/2W x 35 7/8H (inside clearance 16 1/4D x 28W x 34 3/8H)
- B      2 Shelves with Door Hinged Right, Attaches Left and Right  
29 1/2W x 35 7/8H (inside clearance 16 1/4D x 28W x 34 3/8H)
- C      2 Shelves with Door Hinged Right, Attaches Left  
29 1/2W x 35 7/8H (inside clearance 16 1/4D x 28W x 34 3/8H)

### Specify

**Wood**      Units with uniform veneer are provided with the same veneer and finish on the interior and exterior.

**Base**      Units with contrasting veneer are provided with natural ash veneer on the interior and the specified veneer on the exterior.

**Pull**      Grain direction on the interior of units matches the grain direction on the exterior.  
Drawer boxes and waste bins for all units are quarter-cut natural ash with a hand-rubbed tung-oil finish

	Product Number	Depth	Width	Height	Base Price
--	----------------	-------	-------	--------	------------

Sideboard • Shelf Storage  
four units wide

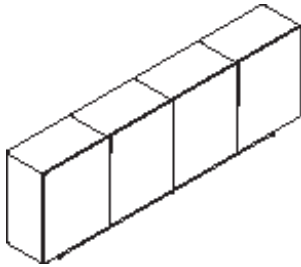

*uniform veneer*  
**IWSS4U-1811840**      17 3/4   118 1/8   39 3/4      \$13,974

*contrasting veneer*  
**IWSS4C-1811840**      17 3/4   118 1/8   39 3/4      \$14,150

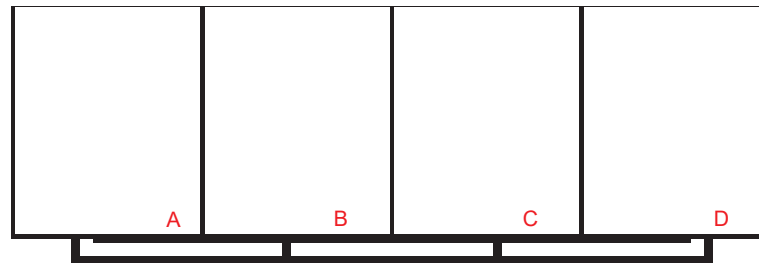
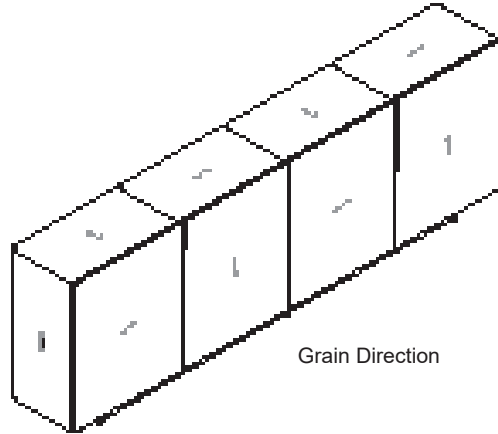

- A      2 Shelves with Door Hinged Left, Attaches Right  
29 1/2W x 35 7/8H (inside clearance 16 1/4D x 28W x 34 3/8H)
- B      2 Shelves with Door Hinged Right, Attaches Left and Right  
29 1/2W x 35 7/8H (inside clearance 16 1/4D x 28W x 34 3/8H)
- C      2 Shelves with Door Hinged Left, Attaches Left and Right  
29 1/2W x 35 7/8H (inside clearance 16 1/4D x 28W x 34 3/8H)
- D      2 Shelves with Door Hinged Right, Attaches Left  
29 1/2W x 35 7/8H (inside clearance 16 1/4D x 28W x 34 3/8H)

**Specify**

Wood      Units with uniform veneer are provided with the same veneer and finish on the interior and exterior.  
Base      Units with contrasting veneer are provided with natural ash veneer on the interior and the specified veneer on the exterior.  
Pull      Grain direction on the interior of units matches the grain direction on the exterior.  
Drawer boxes and waste bins for all units are quarter-cut natural ash with a hand-rubbed tung-oil finish

	Product Number	Depth	Width	Height	Base Price
--	----------------	-------	-------	--------	------------

Sideboard • Mixed Storage  
two units wide

*uniform veneer*  
**IWSM2U-185940**      17 3/4      59      39 3/4      \$16,094

*contrasting veneer*  
**IWSM2C-185940**      17 3/4      59      39 3/4      \$16,290

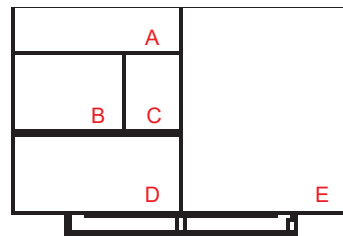
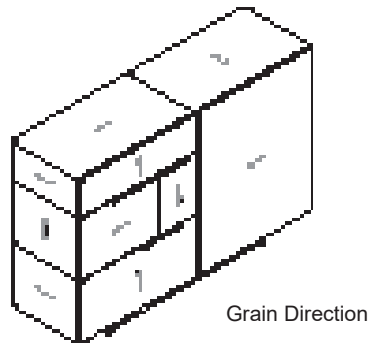
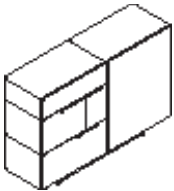

- A      Box Drawer, Attachment Holes Right  
29 1/2W x 8 1/4H
- B      File Drawer, Attachment Holes Right and Top  
19 5/8W x 13 3/4H
- C      Waste Drawer With Removable Waste Bin,  
Attachment Holes Left, Right and Top  
9 7/8W x 13 3/4H
- D      Pull Out Half Height Drawer, Attaches Right and Top  
29 1/2W x 13 3/4H
- E      2 Shelves with Door Hinged Right, Attaches Left  
29 1/2W x 35 7/8H (inside clearance 16 1/4D x 28W x 34 3/8H)

**Specify**

Wood      Units with uniform veneer are provided with the same veneer and finish on the interior and exterior.  
Base      Units with contrasting veneer are provided with natural ash veneer on the interior and the specified veneer on the exterior.  
Pull      Grain direction on the interior of units matches the grain direction on the exterior.  
Drawer boxes and waste bins for all units are quarter-cut natural ash with a hand-rubbed tung-oil finish

Product Number	Depth	Width	Height	Base Price
----------------	-------	-------	--------	------------

Sideboard • Mixed Storage  
three units wide

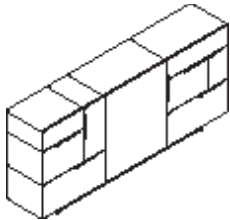

*uniform veneer*  
**IWSM3U-188940**      17 3/4    88 1/2    39 3/4      \$28,314

*contrasting veneer*  
**IWSM3C-188940**      17 3/4    88 1/2    39 3/4      \$28,664

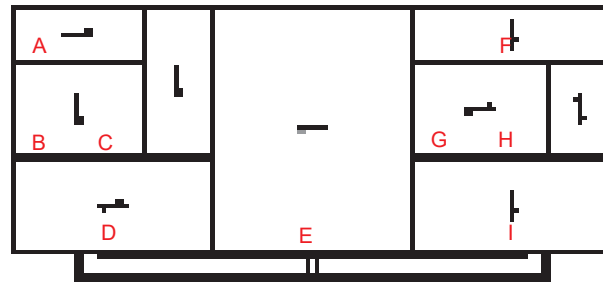
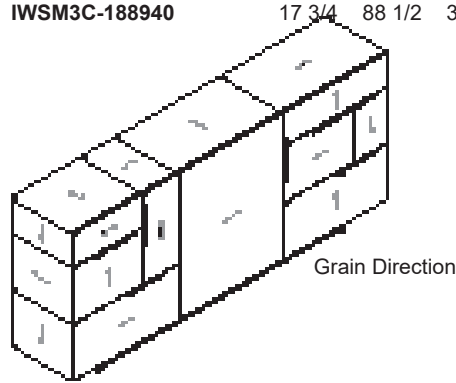

- A      Box Drawer, With Insert Boxes, Attachment Holes Right  
13 3/4W x 8 1/4H
- B      File Drawer, Attachment Holes, Right and Top  
19 5/8W x 13 3/4H
- C      Tower with Door Hinged Right, Attachment Holes Left and Right  
9 7/8W x 22H
- D      Pull Out Half Height Drawer, Attaches Right and Top  
29 1/2W x 13 3/4H
- E      2 Shelves with Door Hinged Left, Attaches Left and Right  
29 1/2W x 35 7/8H (inside clearance 16 1/4D x 28W x 34 3/8H)
- F      Box Drawer, Attachment Holes Left  
29 1/2W x 8 1/4H
- G      File Drawer, Attachment Holes, Left, Right and Top  
19 5/8W x 13 3/4H
- H      Waste Drawer With Removable Waste Bin, Attachment Holes Left and Top  
9 7/8W x 13 3/4H
- I      Pull Out Half Height Drawer, Attaches Left and Top  
29 1/2W x 13 3/4H

**Specify**

Wood      Units with uniform veneer are provided with the same veneer and finish on the interior and exterior.  
Base      Units with contrasting veneer are provided with natural ash veneer on the interior and the specified veneer on the exterior.  
Pull      Grain direction on the interior of units matches the grain direction on the exterior.  
Drawer boxes and waste bins for all units are quarter-cut natural ash with a hand-rubbed tung-oil finish

Product Number	Depth	Width	Height	Base Price
----------------	-------	-------	--------	------------

Sideboard • Mixed Storage  
four units wide

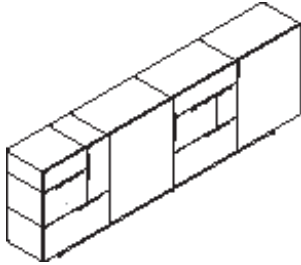

*uniform veneer*  
**IWSM4U-1811840**      17 3/4    118 1/8    39 3/4      \$31,808

*contrasting veneer*  
**IWSM4C-1811840**      17 3/4    118 1/8    39 3/4      \$32,169

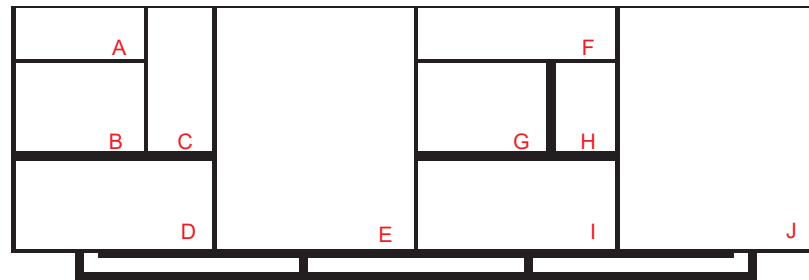
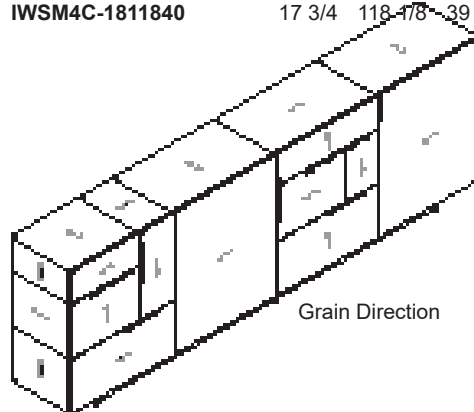

- A      Box Drawer, With Insert Boxes, Attachment Holes Right  
13 3/4W x 8 1/4H
- B      File Drawer, Attachment Holes, Right and Top  
19 5/8W x 13 3/4H
- C      Tower with Door Hinged Right, Attachment Holes Left and Right  
9 7/8W x 22H
- D      Pull Out Half Height Drawer, Attaches Right and Top  
29 1/2W x 13 3/4H
- E      2 Shelves with Door Hinged Left, Attaches Left and Right  
29 1/2W x 35 7/8H (inside clearance 16 1/4D x 28W x 34 3/8H)
- F      Box Drawer, Attachment Holes Left and Right  
29 1/2W x 8 1/4H
- G      File Drawer, Attachment Holes, Left, Right and Top  
19 5/8W x 13 3/4H
- H      Waste Drawer With Removable Waste Bin, Attachment Holes Left, Right, and Top  
9 7/8W x 13 3/4H
- I      Pull Out Half Height Drawer, Attaches Left, Right, and Top  
29 1/2W x 13 3/4H
- J      2 Shelves with Door Hinged Right, Attaches Left  
29-1/2W x 35-7/8H (inside clearance 16 1/4D x 28W x 34 3/8H)

**Specify**

Wood      Units with uniform veneer are provided with the same veneer and finish on the interior and exterior.  
Base      Units with contrasting veneer are provided with natural ash veneer on the interior and the specified veneer on the exterior.  
Pull      Grain direction on the interior of units matches the grain direction on the exterior.  
Drawer boxes and waste bins for all units are quarter-cut natural ash with a hand-rubbed tung-oil finish



<i>Product Number</i>	<i>Page</i>	<i>Product Number</i>	<i>Page</i>	<i>Product Number</i>	<i>Page</i>	<i>Product Number</i>	<i>Page</i>
IWCM2C-185926 .....	16	IWCS3U-188926 .....	14	IWSM2C-185940 .....	22	IWSS3U-188940 .....	20
IWCM2U-185926 .....	16	IWCS4C-1811826 .....	15	IWSM2U-185940 .....	22	IWSS4C-1811840 .....	21
IWCM3C-188926 .....	17	IWCS4U-1811826 .....	15	IWSM3C-188940 .....	23	IWSS4U-1811840 .....	21
IWCM3U-188926 .....	17	IWDSL3C-3072 .....	12	IWSM3U-188940 .....	23	IWT1-36 .....	10
IWCM4C-1811826 .....	18	IWDSL3U-3072 .....	12	IWSM4C-1811840 .....	24	IWT1-48 .....	10
IWCM4U-1811826 .....	18	IWDSL4C-3684 .....	12	IWSM4U-1811840 .....	24		
IWCS2C-185926 .....	13	IWDSL4U-3072 .....	12	IWSS2C-185940 .....	19		
IWCS2U-185926 .....	13	IWDSL4U-3684 .....	12	IWSS2U-185940 .....	19		
IWCS3C-188926 .....	14	IWDSRU-3072 .....	12	IWSS3C-188940 .....	20		
		IWDSRU-3684 .....	12				

Domino™ Tables, Desks & Storage were designed by Isay Weinfeld.

© 2021 Geiger International, Inc. All rights reserved.

® Geiger International is a registered trademark of Geiger International, Inc.

™ The Geiger logo, is a trademark of Geiger International, Inc.