

## Occasional Tables

Prices effective November 1, 2021

Published November 1, 2021

### Specification Information

Terms and Conditions	2
Warranty	3
How to Specify	4
Base Finishes	5
Glass	5
Laminate	5
Leather	6
Stone	6
Wood Finishes	7-9

### Occasional Tables

A Line™	Khodi Feiz	10-11
Brabo™	Vincent Van Duysen	12
Claw™	Ward Bennett	13
Drum™	Amir Paknya	14
Full Round™	Ward Bennett	15
H Frame™	Ward Bennett	15
I Beam™	Ward Bennett	16
Layer™	BassamFellows	17-22
Loophole™	Jay Chapman	23-24
Metal Series™	Geiger Design Group	25-26
Reframe™	EOOS	27
Saiba™	Naoto Fukasawa	28-30
Slimline™	Geiger Design Group	31
Tuxedo™	BassamFellows	32

Index	33
-------	----

# General Information

## Terms and Conditions

## Order Information

# GEIGER

### Application of Standard Terms

Only the standard terms of sale stated in this catalog apply to any transaction unless those terms are modified or supplemented by a written document signed by an officer of Geiger International, Inc. ("Geiger"). Any terms contained in Customer's purchase order, including standard printed provisions, that are additional to or contrary to these terms, are not effective.

### Use of Furniture and Materials

Geiger assumes that textiles, leathers and products are intended for commercial use and are not being bought for use primarily for personal, family, or household purposes. When installed and used as intended, products remain chattel property, are not considered fixtures, and no interest in them should arise under applicable real estate law.

### Furniture Prices

Prices are determined by using the published list prices in effect when Geiger receives Customer's completed purchase order. If Customer's requested ship date is more than three months after Geiger receives Customer's order, it may be repriced using the list prices in effect when products ship. If Customer designates special finishes or options, additional charges may apply. Services such as design, project management, packaging, storage, inside delivery, double handling, installation, or inventory management are not included in Geiger's list prices.

### COM / COL Procedures

If an order includes Customer-supplied materials, Customer must ship those materials to Geiger at Customer's own expense. The materials must be tagged with Geiger's confirmation number, item number, Customer's name, and purchase order number. Geiger is not liable for inadequacies in Customer's materials. Geiger will notify Customer of any apparent defects in Customer's materials before manufacturing.

### Taxes

Customer is responsible for any local sales taxes or other similar taxes imposed on transactions.

### Delays

Geiger is not liable for failure to ship by the acknowledged shipping date or any other date. Geiger is not liable for a delay or failure in shipment or performance if the delay or failure is caused by acts of omission of Customer, its agents, employees, contractors, a governmental authority, or God; delays in transportation; or other similar causes that are not within Geiger's reasonable control. Geiger is excused from further performance of its obligations for the duration of a force majeure cause.

### Changes and Cancellation

Geiger's acceptance of an order is final and binding and an order may not be changed or canceled without Geiger's written consent.

Orders placed on any of Geiger's expedited shipment programs and orders of custom-dyed or custom-woven materials may not be changed or canceled. To change or cancel other orders, contact Geiger Customer Care in writing for authorization and applicable charges.

### Storage

If Customer cannot accept delivery when products are ready, it is the customer's responsibility to transfer products to storage and products are invoiced at that time. Customer is responsible for actual storage charges and any other expenses relating to the storage of products or materials. Customer bears all risk of loss for products or materials in storage.

### Freight Terms

For casegoods and seating orders shipped within the 48 contiguous United States, surface freight charges are included. For textile and leather orders actual freight charges will be invoiced. Orders are shipped via ground carrier unless requested otherwise.

For orders shipped to Alaska or Hawaii, the freight terms stated above apply only to the port of embarkation. Shipments beyond that point are freight collect. Domestic deliveries are shipped FOB Geiger's plant to a destination designated by Customer by a method Geiger selects.

All textile shipments will be made FOB Geiger Textiles, Yaphank, NY 11980. All leather shipments will be made FOB Geiger Textiles, Hildebrand, NC 28637.

### Packaging and Shipping

Geiger's casegoods products are shipped in component form. Shipments over \$50,000 net are blanket wrapped. Tops and panels are shrink wrapped with cardboard corner protection. Pedestals, storage units, overheads and vertical storage units are wrapped in blankets and shrink wrapped with cardboard corner protection. Blankets are to be returned to Geiger for reuse. If the customer request cartoning on orders over \$50,000 net, there will be a charge of five percent of the net order. Packing materials are recyclable.

Casegood shipments from Atlanta under \$50,000 net are cartoned. Cartoned shipments are packaged with cardboard channels and shrink wrap.

Geiger's seating is cartoned in boxes for all shipments. Blanket wrapping is available upon request.

If Customer requests special shipping or delivery methods, Customer is responsible for any extra costs that result.

### Packaging and Shipping (continued)

Customer obtains title to products and materials and assumes the risk of loss for them upon shipment from Geiger's plant. Geiger reserves the right to make partial shipments, of truckload quantities, as products are manufactured.

### Shipping Surcharge

A shipping surcharge will be added to all orders under \$100,000 list based on the ship-to address. The surcharge is a percentage of the total list price of the entire order, calculated on the base price only. Upcharges for veneer, edges, textiles, pulls, etc., are not counted in the calculation.

Zone 1	3.0% (GA, NC, SC)
Zone 2	3.5% (AL, FL, MS, TN, AR, LA)
Zone 3	4.0% (IL, IN, KY, MI, OH, WI, IA, KS, MN, MO, ND, NE, SD, DC, MD, VA)
Zone 4	4.5% (CT, MA, ME, NH, RI, VT, DE, NJ, NY, PA, WV)
Zone 5	5.0% (OK, TX, AZ, NM, NV, UT, CO)
Zone 6	5.5% (OR, WA, ID, MT WY, CA, Canada)

### International Shipping

Orders for export are shipped Ex Works factory (Incoterms 2000). The charge for export packing is five percent of the net order value. There are no export packing charges on shipments to Canada.

### Claims

All blanket wrapped shipments must be unwrapped and inspected at the dock, in the presence of the driver. Claims for "concealed damage" or "subject to inspection" will not be honored on blanket wrapped shipments. All cartoned shipments must be inspected for visual outside damage to the package.

Damages and piece count shortages must be noted on the bill of lading. Freight claims must be filed within 30 days (including cartoned shipments with concealed damage). Contact Customer Care for a warranty/freight claim form and send it by fax, mail or email to:

Geiger International  
6095 Fulton Industrial Blvd., SW  
Atlanta, GA 30336-2806  
Attention: Warranty Department  
Fax: 1.404.836.7519

### Order Information

Herman Miller dealers must submit all purchase orders to Geiger via Omni. For assistance with this process, please contact Herman Miller Sales Technology Support at 800.833.3330.

All Geiger Gallery and non-Herman Miller dealers may submit their orders via email or fax at 404.836.7519. For assistance with this

### Order Information (continued)

process, please contact Geiger Customer Care at 800.456.6452.

Midwest	custcaremw@geigerfurniture.com
New York	custcareny@geigerfurniture.com
Northeast	custcarene@geigerfurniture.com
South	custcaresouth@geigerfurniture.com
West	custcarewest@geigerfurniture.com
Int'l	custcareintl@geigerfurniture.com

### Warranty

Geiger International, Inc. ("Geiger"), 6095 Fulton Industrial Blvd., SW, Atlanta, GA 30336-2806, USA, warrants the products sold by it to be free from defects in material and workmanship, regardless of the number of shifts during which the products are used, for the warranty periods specified below.

This warranty covers the sale of Geiger product in all countries. Not all of the product lines appearing on this list are marketed by Geiger in all countries, and appearance on this list does not imply an offer for sale of a product line in a particular place. Product line availability is defined in current price lists applicable to different regions.

#### Geiger Commercial Office Furniture Products 12 years

All products sold under the Geiger® brand name, except as limited or described below.

#### Textiles and Leathers 3 years

Includes, but is not limited to Edelman Leather, Geiger, Herman Miller, Maharam, and Place fabrics.

#### Nonstandard Products 1 to 5 years

Warranty length on nonstandard products not covered by the 12-year warranty is identified on individual product quotes.

#### All Other Products, Parts, and Services 2 years

Height adjustable bases (electrical parts)

#### 5 years

Height adjustable bases (mechanical parts)  
Task light electronic ballasts

#### 3 years

All service parts

#### 6 months

All other products, parts, and any services not listed above, sold or furnished by Geiger, except for consumable products such as light bulbs and other electronic products for which no warranty is given

#### Other Manufacturers' Products

##### None

Geiger will pass through to the original purchaser any warranty supplied by other manufacturers to the extent possible, including, but not limited

### Warranty (continued)

to, open-line laminates.

#### Provisions that apply to all products and services:

During the applicable warranty period, Geiger, as its sole obligation, will repair or replace (at its option) any product, part, or component covered by this warranty and sold after the effective date of this warranty, which fails under normal use as a result of a defect in material or workmanship; Geiger will repair or replace the aforementioned product, part, or component with a comparable product, part, or component.

This warranty extends only to the original purchasers who acquire new product from Geiger, or its authorized resellers. Any product, part, or component must have been installed, used, and maintained according to Geiger's published instructions in order to be eligible for coverage under this warranty and must not have been subject to misuse or abuse. Any modification to the original product voids the warranty. Geiger does not warrant the performance of the product when used in combination with other than original Geiger product.

The warranty period starts from the date of purchase.

This document inclusively describes all of the warranties given and remedies available with respect to the company's products and services. Geiger disclaims any other warranty whether express or implied, statutory or otherwise, in relation to the products.

Geiger does not warrant:

- natural variations in wood grain or figure or the presence of character marks
- changes in surface finishes due to aging or exposure to light
- marks, scars, or wrinkles occurring naturally in leather
- veins, marks, voids, fissures, or cracks found naturally in stone

In addition, Geiger does not warrant:

- failure resulting from normal wear and tear
- the matching of colors, grains, or textures of natural materials
- the colorfastness or the matching of colors of textiles, including an exact match to cuttings or to swatch cards
- damage, marking, or staining of veneer surfaces due to contact with rubber or similar compounds; damage from sharp objects or imprinting from writing instruments, or prolonged exposure to direct sunlight

Geiger tests Customer's Own Material (COM) and other customer-supplied items for manufacturing quality only and does not provide any warranty with regard to these materials.

Geiger does not warrant products that are

### Warranty (continued)

exposed to extreme environmental conditions or that have been subject to improper storage.

Geiger's products meet the requirements of national and specific local codes as stated in the price books and other written publications.

**TO THE EXTENT ALLOWED BY LAW, ANY IMPLIED WARRANTIES, INCLUDING ANY WARRANTY OF MERCHANTABILITY OR FITNESS FOR A PARTICULAR PURPOSE, ARE DISCLAIMED AND TO THE EXTENT THEY ARE LEGALLY REQUIRED, ARE LIMITED IN DURATION TO THE DURATION OF THIS WRITTEN WARRANTY.**

**GEIGER SHALL NOT BE LIABLE FOR LOSS OF TIME, INCONVENIENCE, COMMERCIAL LOSS, OR INCIDENTAL OR CONSEQUENTIAL DAMAGES.**

Applies in US only: Some states do not allow limitations on how long an implied warranty lasts or do not allow the exclusion or limitation of incidental or consequential damages, so the limitations or exclusions in the two preceding paragraphs may not apply. This warranty gives the purchaser specific legal rights; however, the purchaser may also have other rights that may vary from state to state.

Applies outside US: Except as stated above, Geiger will not be liable for any loss or damage (including costs) however caused, whether direct or consequential, incurred or suffered by the purchaser or any third party in respect of the products but nothing contained herein will or will be considered to exclude or restrict any liability on Geiger's part for death or personal injury resulting from negligence.

### Limitations and Disclaimers

Geiger is not liable for loss of time, inconvenience, lost profits, commercial loss, or other special, consequential, or incidental damages for any transaction.

Geiger reserves the right to change its designs, its methods of construction, or its prices, charges, or policies at any time without notice to Customer.

### Design Rights

The designs depicted in Geiger's catalogs and price lists are proprietary to Geiger and Geiger reserves the exclusive right to manufacture them. Any reproduction of these designs infringes Geiger's rights and that infringement will be prosecuted.

### *How to Specify*

- For each product ordered, specify a product number string. The string should include the product number and all finish and detail codes listed at the bottom of the pricebook page.
- Specify the finishes and details in the same sequence shown on the pricebook page.
- Product Number String Example:  
ALH1A36W 943 CHR CHR

The product number string above includes all required codes for a Lophole round table with walnut base with the following specifications:

Product Number ..... ALH1A-36W  
Wood Finish..... 943 Caramel Cherry  
Glass Finish..... CGL Clear Glass

- Basic Price reflects the price of the table without optional features. Add upcharges as shown on the product page for anigre wood finishes, solid edge detail, etched glass, leg trim, inlay or marquetry. There is no upcharge for anigre base or leg finishes.

Base Finishes	Glass	Laminate
<p><i>For Claw, Metal Series, and Slimline (no upcharge)</i></p> <p>926.....Black                      BNZ .....Bronze                      CHR.....Chrome                      EH.....Metallic Bronze                      MS .....Metallic Silver                      SAC .....Satin Chrome</p>	<p><i>For Claw, H Frame, Loophole, Metal Series, and Slimline table tops and Slimline shelves (no upcharge)</i></p> <p>CGL ..... Clear Glass</p>	<p><i>For Saiba (no upcharge)</i></p> <p>91.....White                      BK.....Black</p>
<p><i>For Brabo, Full Round and H Frame (no upcharge)</i></p> <p>BNZ .....Bronze                      CHR.....Chrome                      SAC .....Satin Chrome</p>	<p><i>For A Line and Saiba table tops (no upcharge)</i></p> <p>GBB ..... Back-painted Black Glass                      GBP ..... Back-painted White Glass</p>	<p><b>Notes</b></p> <p>Laminate edge is black, even if 91 White is selected.</p>
<p><i>For Layer (no upcharge)</i></p> <p>926.....Black                      CHR.....Chrome                      SAC .....Satin Chrome</p>	<p><i>For H Frame table tops (add upcharge shown on the product page)</i></p> <p>GE1 ..... Etched Glass</p>	
<p><i>For Saiba (no upcharge)</i></p> <p>926.....Black                      CHR.....Chrome</p>	<p><i>For Slimline table tops (add upcharge shown on the product page)</i></p> <p>GCE..... Etched Glass Band</p>	
<p><i>For Tuxedo (no upcharge)</i></p> <p>926.....Black                      AS.....Arctic Silver                      PBZ.....Powder Coat Bronze                      WHT .....White</p>	<p><b>Notes</b></p> <p>GCE is clear glass with a 3" wide band of etched glass around the outside edge.</p> <p>CGL glass is 1/2" thick on H Frame and Metal Series tables and 3/4" thick on I Beam tables.</p> <p>GE1 etched glass is 1/2" thick on H Frame tables and is not available on I Beam tables.</p>	
<p><i>For Tuxedo (add upcharge shown on the product page)</i></p> <p>BNZ .....Bronze                      CHR.....Chrome                      SAC .....Satin Chrome</p>		

# Occasional Tables

Leather • Stone

# GEIGER

## Leather

For Brabo leather wrapped tops  
(add upcharge shown on the product page)

### Bristol Leather

- 5-502 ..... Tan
- 5-507 ..... Black
- 5-511 ..... Putty
- 5-512 ..... Grebe
- 5-514 ..... Iona
- 5-519 ..... Hunter
- 5-520 ..... White
- 5-521 ..... Ivory
- 5-522 ..... Parchment
- 5-524 ..... Espresso
- 5-534 ..... Pearl
- 5-537 ..... Caribbean
- 5-546 ..... Pumice
- 5-547 ..... Smoke
- 5-548 ..... Charcoal
- 5-549 ..... Dark Shale
- 5-556 ..... Downtown Grey
- 5-557 ..... City Night
- 5-558 ..... Neutral
- 5-559 ..... Ash Gray
- 5-563 ..... Champagne
- 5-564 ..... Chestnut Brown
- 5-565 ..... Dark Sienna
- 5-566 ..... Earthen
- 5-567 ..... Desert
- 5-568 ..... British Green
- 5-569 ..... Wrought Iron
- 5-579 ..... Paris Blue
- 5-583 ..... Atlantic
- 5-589 ..... Umber
- 5-591 ..... Bone
- 5-592 ..... Camel
- 5-594 ..... Taupe
- 5-597 ..... Pure
- 5-598 ..... Cream
- 5-599 ..... Poppy
- 5-600 ..... Midnight Blue
- 5-601 ..... Deep Aubergine
- 5-602 ..... Merlot
- 5-603 ..... Sangria
- 5-604 ..... Swiss Red
- 5-605 ..... Nordic Yellow
- 5-606 ..... Sky Gray

### MCL Leather

- 1R01 ..... Pearl
- 1R02 ..... Ivory
- 1R03 ..... Almond
- 1R04 ..... Luggage
- 1R05 ..... Red
- 1R06 ..... Brown
- 1R07 ..... Espresso
- 1R08 ..... Stone
- 1R09 ..... Lava
- 1R10 ..... Black

## Stone

For tables with stone top except Layer

- 200 ..... Perlato Polished Marble
- 250 ..... Verde Polished Antique Marble
- 400 ..... Black Polished Granite
- 5U ..... Georgia Grey Polished Marble
- 800 ..... Autumn Brown Polished Granite
- 960 ..... White Carrara Polished Marble
- DP ..... Georgia White Polished Marble
- HR ..... Wisconsin Black Honed Marble

### Notes

Stone is 3/4" thick.

For Layer tables with stone top

- DPH ..... Georgia White Honed Marble
- 5UH ..... Georgia Grey Honed Marble
- HR ..... Wisconsin Black Honed Marble

### Notes

Marble is 1 3/16" thick with radiused edge and radiused corners.

### Wood Finishes

#### Wood Species Key

A	Ash	C	Cherry	O	Oak	SA	Sapele	W	Walnut
AN	Anigre	H	Hickory	P	Paldao	SY	Sycamore	WE	Wenge
B	Beech	M	Maple	R	Rosewood	T	Teak		

Code	Description	Upcharge*	A Line	Brabo	Drum	Full Round	H Frame	Layer	Loophole	Metal Series	Reframe	Saiba	Tuxedo
662	Toasted Walnut, matte		A	AW	W	W	W	W	AW	W	W	AW	W
663	Charred Walnut, matte		A	AW	W	W	W	W	AW	W	W	AW	W
664	Bronzed Walnut, matte		A	AW	W	W	W	W	AW	W	W	AW	W
665	Smoked Walnut, matte		A	AW	W	W	W	W	AW	W	W	AW	W
666	Coffee Walnut, matte		A	AW	W	W	W	W	AW	W	W	AW	W
667	Smoked Paldao, matte	+15%	A	AW	P	P	P		AW	P		AW	W
668	Figured Sycamore, matte	+40%			SY	SY	SY			SY			
669	Warm Paldao, matte	+15%	A	AW	P	P	P		AW	P		AW	W
677	Chocolate Ash, matte		A	A	A	A	A	A	A	A	A	A	A
678	Natural Oak, matte				O	O	O			O			
66A	RecoGrain Frosty Ash, matte		A	A					A			A	A
66G	RecoGrain Wenge, matte	-5%	A	AW					AW			AW	W
66W	RecoGrain Walnut, matte		A	A					A		A	A	A
68R	RecoGrain Rosewood, matte		A	AW	R	R	R		AW	R		AW	W
68W	RecoGrain Walnut, matte	-5%	A	A	W	W	W		A	W	A	A	A
69A	RecoGrain Frosty Ash, matte		A	A	A	A	A		A	A		A	A
69G	RecoGrain Wenge, matte	-5%	A	AW	WE	WE	WE		AW	WE		AW	W
69K	RecoGrain Oak, matte	-5%			O	O	O			O			
69R	RecoGrain Rosewood, matte		A	AW	R	R	R		AW	R		AW	W
69T	RecoGrain Teak, matte		A	A	T	T	T		A	T		A	A
69W	RecoGrain Walnut, matte	-5%	A	A	W	W	W		A	W	A	A	A
6A1	White Ash, matte		A	A	A	A	A	A	A	A	A	A	A
6ET	RecoGrain Natural Ash, Ash Solid, matte		A	A					A			A	A
6EU	RecoGrain Oak, Oak Solid, matte		A	A					A			A	A
6EV	RecoGrain Walnut, Walnut Solid, matte		A	AW					AW			AW	W
6K1	Rift Oak, matte		A	A	O	O	O		A	O		A	A
6K6	Burnt Oak, matte		A	A	O	O	O		A	O		A	A
911	Champagne Maple, low sheen				M	M	M			M			
940	Sundance Cherry on Maple, low sheen		A	A	M	M	M		A	M		A	A
941	Natural Beech, low sheen				B	B	B			B			
942	Sundance Cherry, low sheen				C	C	C			C			
943	Caramel Cherry, low sheen		A	A	C	C	C		A	C		A	A
946	Cocoa Cherry, low sheen		A	A	C	C	C		A	C		A	A
951	Natural Anigre, low sheen	+40%			AN	AN	AN			AN			
956	Cocoa Sapele, low sheen		A	A	SA	SA	SA		A	SA		A	A
962	Toasted Walnut, low sheen		A	AW	W	W	W		AW	W		AW	W

\*Wood finish upcharge / downcharge applies only to Drum, Full Round, H Frame, and Metal Series tables. All other tables are produced in the wood species indicated and stained to match the color of the specified wood finish.

# Occasional Tables

## Wood Finishes

# GEIGER

### Wood Finishes (Continued)

#### Wood Species Key

A	Ash	C	Cherry	O	Oak	SA	Sapele	W	Walnut
AN	Anigre	H	Hickory	P	Paldao	SY	Sycamore	WE	Wenge
B	Beech	M	Maple	R	Rosewood	T	Teak		

Code	Description	Upcharge*	A Line	Brabo	Drum	Full Round	H Frame	Layer	Loophole	Metal Series	Reframe	Saiba	Tuxedo
963	Charred Walnut, low sheen		A	A W	W	W	W		A W	W		A W	W
964	Bronzed Walnut, low sheen		A	A W	W	W	W		A W	W		A W	W
965	Smoked Walnut, low sheen		A	A W	W	W	W		A W	W		A W	W
966	Coffee Walnut, low sheen		A	A W	W	W	W		A W	W		A W	W
967	Smoked Paldao, low sheen	+15%	A	A W	P	P	P		A W	P		A W	W
968	Figured Sycamore, low sheen	+40%			SY	SY	SY			SY			
969	Warm Paldao, low sheen	+15%	A	A W	P	P	P		A W	P		A W	W
972	Sundance Walnut, low sheen			W				W	W		W	W	W
977	Chocolate Ash, low sheen		A	A	A	A	A		A	A		A	A
978	Natural Oak, low sheen				O	O	O			O			
981	Champagne Hickory, low sheen				H	H	H			H			
991	Champagne Ash, low sheen		A	A	A	A	A	A	A	A	A	A	A
998	Ebony Ash, low sheen		A	A	A	A	A	A	A	A	A	A	A
96A	RecoGrain Frosty Ash, low sheen		A	A					A			A	A
96G	RecoGrain Wenge, low sheen	-5%	A	A W					A W			A W	W
96W	RecoGrain Walnut, low sheen		A	A					A		A	A	A
98R	RecoGrain Rosewood, low sheen		A	A W	R	R	R		A W	R		A W	W
98W	RecoGrain Walnut, low sheen	-5%	A	A	W	W	W		A	W	A	A	A
99A	RecoGrain Frosty Ash, low sheen				A	A	A			A			
99G	RecoGrain Wenge, low sheen	-5%	A	A W	WE	WE	WE		A W	WE		A W	W
99K	RecoGrain Oak, low sheen	-5%			O	O	O			O			
99R	RecoGrain Rosewood, low sheen		A	A W	R	R	R		A W	R		A W	W
99T	RecoGrain Teak, low sheen		A	A	T	T	T		A	T		A	A
99W	RecoGrain Walnut, low sheen	-5%	A	A	W	W	W		A	W	A	A	A
9A1	White Ash, low sheen		A	A	A	A	A		A	A		A	A
9K1	Rift Oak, low sheen		A	A	O	O	O		A	O		A	A
9K6	Burnt Oak, low sheen		A	A	O	O	O		A	O		A	A
ED	Aged Cherry, low sheen		A	A	C	C	C		A	C		A	A
EK	Medium Red Walnut, low sheen		A	A W	W	W	W	W	A W	W	W	A W	W
ET	RecoGrain Natural Ash, matte		A	A	A	A	A		A	A		A	A
EU	RecoGrain Oak, matte		A	A	O	O	O		A	O		A	A
EV	RecoGrain Walnut, matte		A	A W	W	W	W		A W	W		A W	W
G2U	Light Brown Walnut, low sheen		A	A W	W	W	W	W	A W	W	W	A W	W
G40	Dark Brown Walnut, low sheen		A	A W	W	W	W	W	A W	W	W	A W	W
GOU	Walnut, matte		A	A W		W	W	W	A W		W	A W	W
UX	Walnut On Cherry, low sheen		A	A	C	C	C		A	C		A	A

\*Wood finish upcharge / downcharge applies only to Drum, Full Round, H Frame, and Metal Series tables. All other tables are produced in the wood species indicated and stained to match the color of the specified wood finish.



#### Wood Finishes (Continued)

##### Notes

Natural wood finishes are unstained to maintain the natural beauty and clarity of the wood. When the veneer and solid wood species are not the same the veneer and solid may differ in color and graining. When a stained wood finish is specified, the solid wood edges are stained to match the veneer top as closely as possible.

Special finish colors may be developed for orders over \$200,000 list upon request at no additional charge. A one time set-up fee of \$250 net will be charged on orders under \$200,000 list for each special finish. In order

to protect the quality and durability of Geiger's finish, the chemical composition of the staining materials, water-base sealers, and urethane top coats will not be altered for special finishes.

Exotic veneers such as pearwood, bird's eye maple and sycamore are available upon request, at additional cost.

For further information and procedures for special finishes or exotic veneers, contact your Geiger sales representative.

##### Custom Veneer Layup

Custom veneer layup is available on selected tables with one-piece tops. Contact your Geiger sales representative for availability, ordering information and upcharges.

Sunburst layup is not available in maple, bird's-eye maple or sycamore.

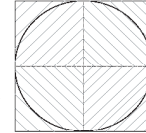

Diamond

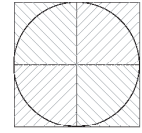

Reverse Diamond

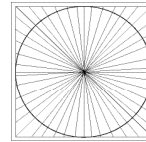

Sunburst

# Occasional Tables

A-Line • Wood Top

# GEIGER

	Product Number	Depth	Width	Height	Basic Price
<b>A Line • Round</b> <i>wood top</i>	<b>AAL1B-18</b>	18	18	19 3/4	\$1,659
	<b>AAL1A-36</b>	36	36	13 3/4	\$1,890

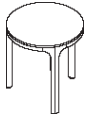

*Top.....ash veneer*  
*Base .....solid ash*

<b>A Line • Square</b> <i>wood top</i>	<b>AAL2B-2222</b>	22	22	19 3/4	\$1,718
	<b>AAL2A-3636</b>	36	36	13 3/4	\$1,857
	<b>AAL2C-3636</b>	36	36	28 7/8	\$2,167



*Top.....ash veneer*  
*Base .....solid ash*

<b>A Line • Rectangular</b> <i>wood top</i>	<b>AAL3B-2622</b>	26	22	19 3/4	\$1,753
	<b>AAL3C-3672</b>	36	72	28 7/8	\$2,823



*Top.....ash veneer*  
*Base .....solid ash*

## Specify

Wood Finish

	Product Number	Depth	Width	Height	Basic Price
<b>A Line • Round</b> <i>glass top</i>	<b>AAG1B-18</b>	18	18	19 3/4	\$1,712
	<b>AAG1A-36</b>	36	36	13 3/4	\$2,680



*Top.....back-painted glass*  
*Base .....solid ash*

<b>A Line • Square</b> <i>glass top</i>	<b>AAG2B-2222</b>	22	22	19 3/4	\$1,942
	<b>AAG2A-3636</b>	36	36	13 3/4	\$2,639
	<b>AAG2C-3636</b>	36	36	28 7/8	\$2,957



*Top.....back-painted glass*  
*Base .....solid ash*

<b>A Line • Rectangular</b> <i>glass top</i>	<b>AAG3B-2622</b>	26	22	19 3/4	\$2,005
	<b>AAG3C-3672</b>	36	72	28 7/8	\$4,684

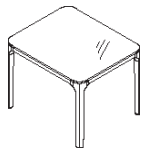

*Top.....back-painted glass*  
*Base .....solid ash*

### Specify

Wood Finish  
Glass

# Occasional Tables

## Brabo

# GEIGER

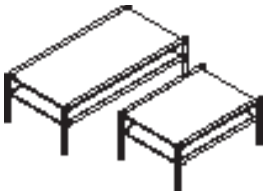
	Product Number	Depth	Width	Height	Basic Price	Leather Upcharges	
						Bristol	HMI
<b>Brabo</b> <i>wood top</i> 	<i>ash frame</i>						
	<b>AV3AW-332314</b>	33	23	15 3/4	\$2,483		
	<b>AV3AW-234814</b>	23	48	15 3/4	\$2,707		
	<i>walnut frame</i>						
	<b>AV3WW-332314</b>	33	23	15 3/4	\$2,576		
	<b>AV3WW-234814</b>	23	48	15 3/4	\$2,834		
	<i>Top.....ash or walnut veneer</i> <i>Frame .....solid ash or walnut and steel plated metal</i>						

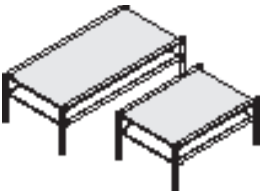
<b>Brabo</b> <i>leather wrapped top</i> 	<i>ash frame</i>						
	<b>AV3AL-332314</b>	33	23	15 3/4	\$2,483	+193	+216
	<b>AV3AL-234814</b>	23	48	15 3/4	\$2,707	+290	+324
	<i>walnut frame</i>						
	<b>AV3WL-332314</b>	33	23	15 3/4	\$2,576	+193	+216
	<b>AV3WL-234814</b>	23	48	15 3/4	\$2,834	+290	+324
	<i>Top.....wrapped in Bristol or MCL leather</i> <i>Frame .....solid ash or walnut and steel plated metal</i>						

### Specify

Wood Finish  
 Leather, only available in Bristol or MCL leather (not required on tables with wood top)  
 Base Finish

	Product Number	Depth	Width	Height	Basic Price
<b>Claw • Tri-Leg Round</b>	<b>ACL1A-20</b>	20	20	16	\$2,328
	<b>ACL1A-24</b>	24	24	16	\$2,563
	<b>ACL1A-36</b>	36	36	16	\$3,726



Top.....3/4" thick clear glass  
 Base .....metal

---

<b>Claw • Four-Leg Square</b>	<b>ACL2A-3636</b>	36	36	16	\$3,751
	<b>ACL2A-4040</b>	40	40	16	\$4,044



Top.....3/4" thick clear glass  
 Base .....metal

**Specify**

Base Finish

# Occasional Tables

Drum

# GEIGER

	Product Number	Depth	Width	Height	Basic Price
<b>Drum</b> <i>wood veneered</i>	<b>ADT1B-24</b>	24	24	24	\$3,308



## Specify

*Wood Finish*

	Product Number	Depth	Width	Height	Basic Price	Etched Glass
<b>Full Round Table</b> <i>wood top</i> 	<b>AWR2-2020</b>	20	20	17	\$1,891	
	<b>AWR2-2424</b>	24	24	17	\$2,143	
	<b>AWR2-3030</b>	30	30	17	\$2,339	
	<b>AWR2-3020</b>	30	20	17	\$2,567	
	<b>AWR2-4020</b>	40	20	17	\$2,502	

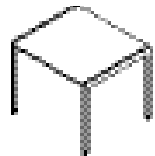
<b>H Frame Table</b> 	<i>with wood top</i> <b>AWH2W-1820</b>	18	20	17	\$2,264	
	<i>with glass top</i> <b>AWH2G-1820</b>	18	20	17	\$1,718	+136
	<i>with stone top</i> <b>AWH2S-1820</b>	18	20	17	\$2,997	

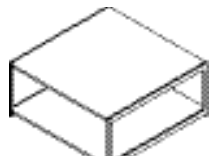
<b>H Frame Table</b> 	<i>with wood top</i> <b>AWH2W-3636</b>	36	36	17	\$4,095	
	<i>with glass top</i> <b>AWH2G-3636</b>	36	36	17	\$3,659	+310
	<i>with stone top</i> <b>AWH2S-3636</b>	36	36	17	\$7,821	

*Note: clearance between bottom shelf and underside of top is 13"*

### Specify

*Wood Finish (required on wood tables only)*

*Glass (required on glass tables only)*

*Stone (required on stone tables only)*

*Base Finish*

# Occasional Tables

## I Beam

# GEIGER

	Product Number	Depth	Width	Height	Basic Price
<b>I Beam Table</b>	<b>AWB1Z-161615</b>	16	16	14 1/2	\$1,949
	<b>AWB1Z-181815</b>	18	18	14 1/2	\$2,090



Base .....black powder-coated cast aluminum

---

<b>I Beam Table • Glass Top</b>	<b>AWB2G-363615</b>	36	36	15 1/4	\$2,993
	<b>AWB2G-404015</b>	40	40	15 1/4	\$3,219

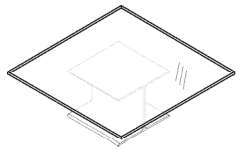

Top..... CGL Glass, 3/4" thick  
Base .....black powder-coated cast aluminum

---

<b>I Beam Table • Stone Top</b>	<b>AWB2M-363616</b>	36	36	16	\$6,041
	<b>AWB2M-404016</b>	40	40	16	\$6,606

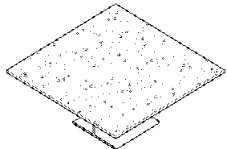

Top..... 3/4" thick with 3/4" thick painted recessed sub top painted to match stone,  
sub top is recessed 6" all around  
Base .....black powder-coated cast aluminum

### Specify

Glass (required on glass tables only), available only in CGL clear glass, GE1 etched glass not available on I Beam tables  
Stone (required on stone tables only)



	Product Number	Depth	Width	Height	Basic Price
<b>Layer</b> <i>no shelf</i>	<b>ALYSN-28Z14Z16Z</b>	14	28	16	\$1,351
	<b>ALYSN-28Z22Z16Z</b>	22	28	16	\$1,577
	<b>ALYSN-46Z24Z16Z</b>	24	46	16	\$2,140
	<b>ALYSN-66Z28Z16Z</b>	28	66	16	\$2,480



*Glass Top ..... 1/2" thick low iron tempered glass with radiused top edge and radiused corners*  
*Base ..... stainless steel*

### Specify

*Base Finish*

# Occasional Tables

Layer • Stone Shelf

# GEIGER

	Product Number	Depth	Width	Height	Basic Price
--	----------------	-------	-------	--------	-------------

**Layer**  
stone shelf



	<b>ALYSS-28Z14Z16Z</b>	14	28	16	\$2,704
	<b>ALYSS-28Z22Z16Z</b>	22	28	16	\$2,931
	<b>ALYSS-46Z24Z16Z</b>	24	46	16	\$4,285
	<b>ALYSS-66Z28Z16Z</b>	28	66	16	\$4,737

*Glass Top ..... 1/2" thick low iron tempered glass with radiused top edge and radiused corners*  
*Base ..... stainless steel*  
*Stone Shelf ..... 1 3/16" thick with radiused edge and radiused corners.*

## Specify

Stone Finish  
Base Finish

	Product Number	Depth	Width	Height	Basic Price
<b>Layer</b> <i>wood shelf</i> 	<i>ash shelf</i>				
	<b>ALYSA-28Z14Z16Z</b>	14	28	16	\$1,915
	<b>ALYSA-28Z22Z16Z</b>	22	28	16	\$2,366
	<b>ALYSA-46Z24Z16Z</b>	24	46	16	\$2,704
	<b>ALYSA-66Z28Z16Z</b>	28	66	16	\$3,156
	<i>walnut shelf</i>				
	<b>ALYSW-28Z14Z16Z</b>	14	28	16	\$1,915
	<b>ALYSW-28Z22Z16Z</b>	22	28	16	\$2,366
	<b>ALYSW-46Z24Z16Z</b>	24	46	16	\$2,704
	<b>ALYSW-66Z28Z16Z</b>	28	66	16	\$3,156

*Glass Top* ..... 1/2" thick low iron tempered glass with radiused top edge and radiused corners  
*Base* ..... stainless steel  
*Wood Shelf* ..... 1" thick with plank veneer layup, solid wood edge, and finished to match color and sheen of specified wood finish.

**Specify**

*Wood Finish*  
*Base Finish*

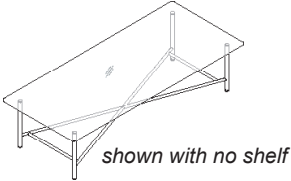
	Product Number	Depth	Width	Height	Basic Price
<b>Layer</b> <i>nesting table, high</i> 	<i>no shelf</i> <b>ALNHSN-66Z28Z16Z</b>	28	66	16	\$2,479
	<i>ash shelf</i> <b>ALNHSA-66Z28Z16Z</b>	28	66	16	\$3,608
	<i>walnut shelf</i> <b>ALNHSW-66Z28Z16Z</b>	28	66	16	\$3,608
	<i>stone shelf</i> <b>ALNHSS-66Z28Z16Z</b>	28	66	16	\$5,753

*Glass Top ..... 1/2" thick low iron tempered glass with radiused top edge and radiused corners*  
*Base ..... stainless steel*  
*Wood Shelf ..... 1" thick with plank veneer layup, solid wood edge, and finished to match color and sheen of specified wood finish.*

### Specify

*Wood Finish (for tables with wood shelf)*  
*Stone Finish (for tables with stone shelf)*  
*Base Finish*

# Occasional Tables

Layer • Nesting Table • Low

# GEIGER

	Product Number	Depth	Width	Height	Basic Price
--	----------------	-------	-------	--------	-------------

**Layer**  
nesting table, low

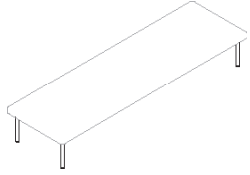

<i>ash shelf</i> <b>ALNLTA-66Z20Z10Z</b>	20	66	10	\$2,027
<i>walnut shelf</i> <b>ALNLTW-66Z20Z10Z</b>	20	66	10	\$2,027

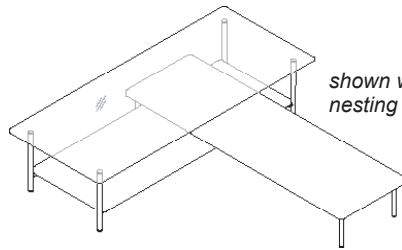

Base ..... stainless steel  
Wood top ..... 1 1/4" thick with plank veneer layup, solid wood edge, and finished to match color and sheen of specified wood finish.



shown with ALNHSA-66Z28Z16Z  
nesting table, high

## Specify

Stone Finish  
Base Finish

	Product Number	Depth	Width	Height	Basic Price
<b>Loophole • Round</b> 	<i>walnut frame</i>				
	<b>ALH1A-36W</b>	36	36	14	\$2,051
	<b>ALH1A-42W</b>	42	42	14	\$2,282
	<i>ash frame</i>				
	<b>ALH1A-36A</b>	36	36	14	\$1,753
	<b>ALH1A-42A</b>	42	42	14	\$1,960
	<i>Top..... 1/2' low iron clear glass with flat polished edge</i>				
	<i>Base .....solid ash or solid walnut</i>				
<b>Loophole • Square</b> 	<i>walnut frame</i>				
	<b>ALH2A-3636W</b>	36	36	14	\$2,161
	<b>ALH2A-4242W</b>	42	42	14	\$2,427
	<i>ash frame</i>				
	<b>ALH2A-3636A</b>	36	36	14	\$1,868
	<b>ALH2A-4242A</b>	42	42	14	\$2,110
	<i>Top..... 1/2' low iron clear glass with flat polished edge</i>				
	<i>Base .....solid ash or solid walnut</i>				
<b>Loophole • Rectangular</b> 	<i>walnut frame</i>				
	<b>ALH3A-2436W</b>	24	36	14	\$1,868
	<b>ALH3A-3042W</b>	30	42	14	\$2,219
	<i>ash frame</i>				
	<b>ALH3A-2436A</b>	24	36	14	\$1,637
	<b>ALH3A-3042A</b>	30	42	14	\$1,863
	<i>Top..... 1/2' low iron clear glass with flat polished edge</i>				
	<i>Base .....solid ash or solid walnut</i>				



*Note: table base can be installed in the field inverted with the wide end at the bottom*

### Specify

Wood Finish (available only in ash and walnut)  
 Glass (available only in CGL clear glass)

# Occasional Tables

## Loophole • End Table

GEIGER

	Product Number	Depth	Width	Height	Basic Price
<b>Loophole • Round</b>	<i>walnut frame</i> <b>ALH1B-21W</b>	21	21	20	\$1,608
	<i>ash frame</i> <b>ALH1B-21A</b>	21	21	20	\$1,384
 <p><i>Top..... 1/2' low iron clear glass with flat polished edge</i> <i>Base ..... solid ash or solid walnut</i></p>					

<b>Loophole • Square</b>	<i>walnut frame</i> <b>ALH2B-2121W</b>	21	21	20	\$1,666
	<i>ash frame</i> <b>ALH2B-2121A</b>	21	21	20	\$1,448
 <p><i>Top..... 1/2' low iron clear glass with flat polished edge</i> <i>Base ..... solid ash or solid walnut</i></p>					



*note: table base can be installed in the field inverted with the wide end at the bottom*

### Specify

*Wood Finish (available only in ash and walnut)*  
*Glass (available only in CGL clear glass)*

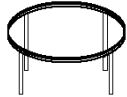
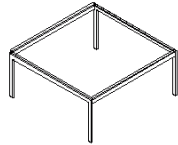
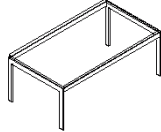
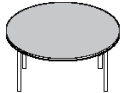
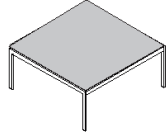
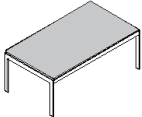
	Product Number	Depth	Width	Height	Basic Price
<b>Metal Series • Round</b> <i>with glass top</i> 	<b>AMS4A-24</b>	24	24	16	\$2,190
	<b>AMS4A-30</b>	30	30	16	\$2,582
	<b>AMS4A-36</b>	36	36	16	\$3,175
	<b>AMS4A-42</b>	42	42	16	\$3,803
	<b>AMS4B-24</b>	24	24	20	\$2,247
	<i>Top..... 1/2" thick clear glass</i> <i>Base .....metal</i>				
<b>Metal Series • Square</b> <i>with glass top</i> 	<b>AMS5A-2424</b>	24	24	16	\$2,190
	<b>AMS5A-3636</b>	36	36	16	\$3,175
	<b>AMS5B-2424</b>	24	24	20	\$2,265
	<i>Top..... 1/2" thick clear glass</i> <i>Base .....metal</i>				
<b>Metal Series • Rectangular</b> <i>with glass top</i> 	<b>AMS6-2442</b>	24	42	16	\$2,473
	<b>AMS6-2448</b>	24	48	16	\$2,634
	<i>Top..... 1/2" thick clear glass</i> <i>Base .....metal</i>				
<b>Metal Series • Round</b> <i>with stone top</i> 	<b>AMS7A-24</b>	24	24	16	\$3,710
	<b>AMS7A-30</b>	30	30	16	\$4,884
	<b>AMS7A-36</b>	36	36	16	\$6,564
	<b>AMS7A-42</b>	42	42	16	\$8,310
	<b>AMS7B-24</b>	24	24	20	\$3,751
	<i>Top..... 3/4" thick stone</i> <i>Base .....metal</i>				
<b>Metal Series • Square</b> <i>with stone top</i> 	<b>AMS8A-2424</b>	24	24	16	\$3,710
	<b>AMS8A-3636</b>	36	36	16	\$6,564
	<b>AMS8B-2424</b>	24	24	20	\$3,784
	<i>Top..... 3/4" thick stone</i> <i>Base .....metal</i>				
<b>Metal Series • Rectangular</b> <i>with stone top</i> 	<b>AMS9-2442</b>	24	42	16	\$4,920
	<b>AMS9-2448</b>	24	48	16	\$5,270
	<i>Top..... 3/4" thick stone</i> <i>Base .....metal</i>				

### Specify

Stone (required on stone tables only)  
 Glass (required on glass tables only), available only in CGL clear glass  
 Base Finish



# Occasional Tables

Metal Series • Wood Top

# GEIGER

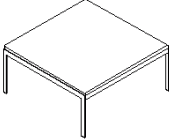
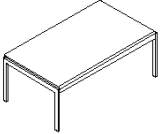
	Product Number	Depth	Width	Height	Basic Price
<b>Metal Series • Round</b> <i>with wood top</i> 	<b>AMW1A-24</b>	24	24	16	\$1,968
	<b>AMW1A-30</b>	30	30	16	\$2,247
	<b>AMW1A-36</b>	36	36	16	\$2,691
	<b>AMW1A-42</b>	42	42	16	\$3,116
	<b>AMW1B-24</b>	24	24	20	\$2,023
	<i>Top.....3/4" thick wood</i> <i>Base .....metal</i>				
<b>Metal Series • Square</b> <i>with wood top</i> 	<b>AMW2A-2424</b>	24	24	16	\$1,988
	<b>AMW2A-3636</b>	36	36	16	\$2,691
	<b>AMW2B-2424</b>	24	24	20	\$2,046
	<i>Top.....3/4" thick wood</i> <i>Base .....metal</i>				
<b>Metal Series • Rectangular</b> <i>with wood top</i> 	<b>AMW3-2442</b>	24	42	16	\$2,046
	<b>AMW3-2448</b>	24	48	16	\$2,155
	<i>Top.....3/4" thick wood</i> <i>Base .....metal</i>				

## Specify

Wood Finish  
Base Finish

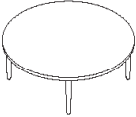
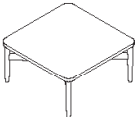
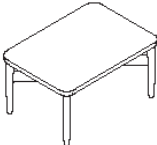
	Product Number	Depth	Width	Height	Basic Price
<b>Reframe • Round</b> 	<i>ash</i> <b>AFC A</b>	36 1/4"	36 1/4"	13 7/8"	\$1,213
	<i>walnut</i> <b>AFC W</b>	36 1/4"	36 1/4"	13 7/8"	\$1,545
<i>Top..... 1 1/2" thick, veneered top with solid edge</i>					
<i>Legs..... solid wood</i>					
<b>Reframe • Square</b> 	<i>ash</i> <b>AFSA</b>	26 1/2"	26 1/2"	13 7/8"	\$1,102
	<i>walnut</i> <b>AFSW</b>	26 1/2"	26 1/2"	13 7/8"	\$1,434
<i>Top..... 1 1/2" thick, veneered top with solid edge</i>					
<i>Legs..... solid wood</i>					
<b>Reframe • Rectangular</b> 	<i>ash</i> <b>AFRA</b>	18 7/8"	26 1/2"	13 7/8"	\$935
	<i>walnut</i> <b>AFRW</b>	18 7/8"	26 1/2"	13 7/8"	\$1,157
<i>Top..... 1 1/2" thick, veneered top with solid edge</i>					
<i>Legs..... solid wood</i>					

### Specify

Wood Finish

# Occasional Tables

Saiba • Wood Top

# GEIGER

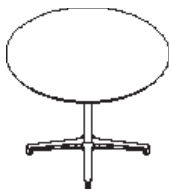
	Product Number	Depth	Width	Height	Basic Price
	<i>ash</i>				
	<b>ASB1A-1630</b>	30	30	16	\$1,844
	<b>ASB1A-1636</b>	36	36	16	\$2,017
	<b>ASB1A-1640</b>	40	40	16	\$2,190
	<b>ASB1A-2630</b>	30	30	26 1/2	\$1,903
	<b>ASB1A-2636</b>	36	36	26 1/2	\$2,074
	<b>ASB1A-2640</b>	40	40	26 1/2	\$2,247
	<b>ASB1A-2930</b>	30	30	29	\$1,959
	<b>ASB1A-2936</b>	36	36	29	\$2,131
	<b>ASB1A-2940</b>	40	40	29	\$2,304
	<i>walnut</i>				
	<b>ASB1W-1630</b>	30	30	16	\$1,959
	<b>ASB1W-1636</b>	36	36	16	\$2,131
	<b>ASB1W-1640</b>	40	40	16	\$2,304
	<b>ASB1W-2630</b>	30	30	26 1/2	\$2,017
	<b>ASB1W-2636</b>	36	36	26 1/2	\$2,190
	<b>ASB1W-2640</b>	40	40	26 1/2	\$2,362
	<b>ASB1W-2930</b>	30		29	\$2,074
	<b>ASB1W-2936</b>	36		29	\$2,247
	<b>ASB1W-2940</b>	40		29	\$2,420

Top.....ash or walnut veneer  
 Base .....black or chrome finished aluminum

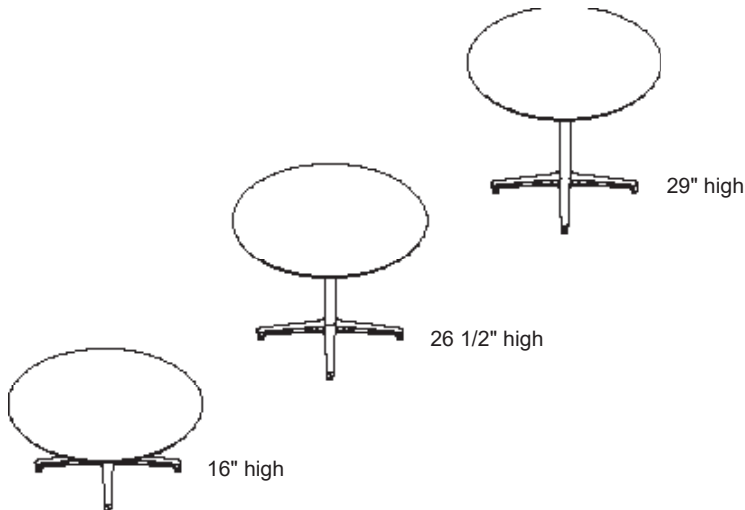

## Specify

Wood Finish  
 Base Finish

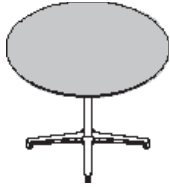
	Product Number	Depth	Width	Height	Basic Price
<b>Saiba</b> 	<i>laminata</i>				
	<b>ASB1T-1630</b>	30	30	16	\$1,498
	<b>ASB1T-1636</b>	36	36	16	\$1,844
	<b>ASB1T-1640</b>	40	40	16	\$2,304
	<b>ASB1T-2630</b>	30	30	26 1/2	\$1,555
	<b>ASB1T-2636</b>	36	36	26 1/2	\$1,903
	<b>ASB1T-2640</b>	40	40	26 1/2	\$2,362
	<b>ASB1T-2930</b>	30	30	29	\$1,612
	<b>ASB1T-2936</b>	36	36	29	\$1,959
	<b>ASB1T-2940</b>	40	40	29	\$2,420

Top.....laminata with black edge  
Base .....aluminum

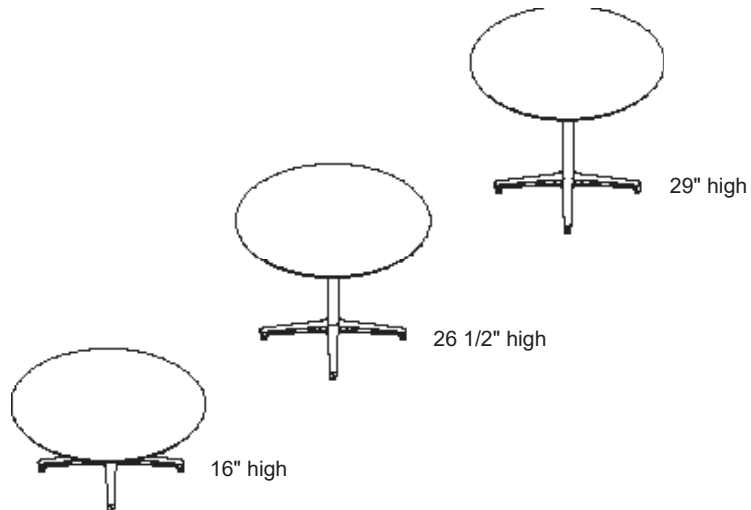

### Specify

Base Finish  
Laminata

# Occasional Tables

Saiba • Glass Top

# GEIGER

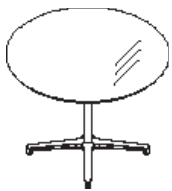
	Product Number	Depth	Width	Height	Basic Price
<b>Saiba</b> 	<i>back-painted glass</i>				
	<b>ASB1G-1630</b>	30	30	16	\$2,304
	<b>ASB1G-1636</b>	36	36	16	\$2,879
	<b>ASB1G-1640</b>	40	40	16	\$3,456
	<b>ASB1G-2630</b>	30	30	26 1/2	\$2,362
	<b>ASB1G-2636</b>	36	36	26 1/2	\$2,937
	<b>ASB1G-2640</b>	40	40	26 1/2	\$3,514
	<b>ASB1G-2930</b>	30	30	29	\$2,420
	<b>ASB1G-2936</b>	36	36	29	\$2,996
	<b>ASB1G-2940</b>	40	40	29	\$3,571

Top.....back-painted glass  
Base .....black or chrome finished aluminum

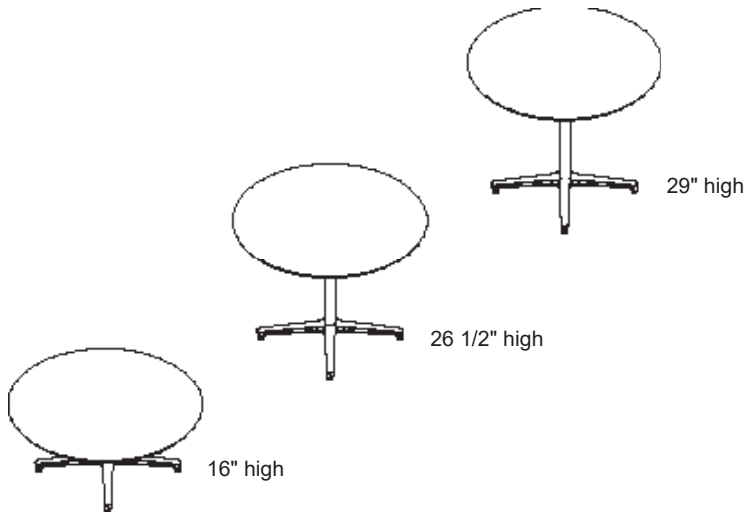

## Specify

Glass  
Base Finish

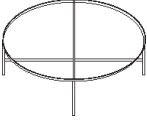
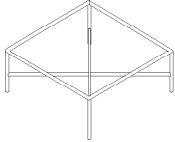
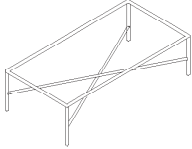
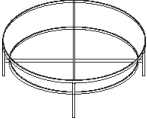
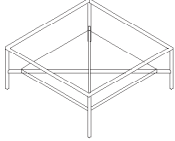
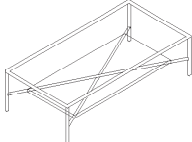
	Product Number	Depth	Width	Height	Basic Price	Etched Glass
<b>Slimline • Round</b> 	<b>ASL1A-20</b>	20	20	16	\$1,666	+117
	<b>ASL1A-24</b>	24	24	16	\$1,800	+146
	<b>ASL1A-30</b>	30	30	16	\$2,087	+260
	<b>ASL1A-36</b>	36	36	16	\$2,420	+361
	<i>Top..... 1/2" thick clear or etched glass</i> <i>Base .....metal</i>					
<b>Slimline • Square</b> 	<b>ASL2A-2424</b>	24	24	16	\$1,730	+146
	<i>Top..... 1/2" thick clear or etched glass</i> <i>Base .....metal</i>					
<b>Slimline • Rectangular</b> 	<b>ASL3-2436</b>	24	36	16	\$2,023	+146
	<b>ASL3-2442</b>	24	42	16	\$2,172	+260
	<b>ASL3-2448</b>	24	48	16	\$2,270	+260
	<b>ASL3-2454</b>	24	54	16	\$2,461	+361
	<i>Top..... 1/2" thick clear or etched glass</i> <i>Base .....metal</i>					
<b>Slimline • Round</b> <i>with glass shelf</i> 	<b>ASL4A-30</b>	30	30	16	\$2,437	+146
	<b>ASL4A-36</b>	36	36	16	\$2,888	+361
	<b>ASL4A-42</b>	42	42	16	\$3,486	+493
	<i>Note: clearance between bottom shelf and underside of top is 8 3/8"</i> <i>Top..... 1/2" thick clear or etched glass</i> <i>Shelf ..... 1/2" thick clear glass</i> <i>Base .....metal</i>					
<b>Slimline • Square</b> <i>with glass shelf</i> 	<b>ASL5A-3636</b>	36	36	16	\$2,623	+361
	<b>ASL5A-4242</b>	42	42	16	\$3,072	+493
	<i>Note: clearance between bottom shelf and underside of top is 8 3/8"</i> <i>Top..... 1/2" thick clear or etched glass</i> <i>Shelf ..... 1/2" thick clear glass</i> <i>Base .....metal</i>					
<b>Slimline • Rectangular</b> <i>with glass shelf</i> 	<b>ASL6-2436</b>	24	36	16	\$2,270	+146
	<b>ASL6-2442</b>	24	42	16	\$2,495	+260
	<b>ASL6-2448</b>	24	48	16	\$2,623	+260
	<b>ASL6-2454</b>	24	54	16	\$2,834	+361
	<i>Note: clearance between bottom shelf and underside of top is 8 3/8"</i> <i>Top..... 1/2" thick clear or etched glass</i> <i>Shelf ..... 1/2" thick clear glass</i> <i>Base .....metal</i>					



### Specify

Glass  
Base Finish

# Occasional Tables

## Tuxedo

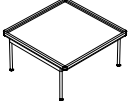
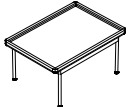
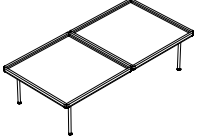
# GEIGER

	Product Number	Depth	Width	Height	Basic Price	Base
<b>Tuxedo • Square</b>	<b>AXW2-2828</b>	28	28	14	\$1,862	+307
	<i>Top.....walnut or ash veneer</i> <i>Base .....steel plated metal</i>					
<b>Tuxedo • Rectangular</b>	<b>AXW3-2028</b>	20	28	14	\$1,649	+307
	<i>Top.....walnut or ash veneer</i> <i>Base .....steel plated metal</i>					
<b>Tuxedo • Rectangular</b>	<b>AXW3-2856</b>	28	56	14	\$3,105	+671
	<i>Top.....walnut or ash veneer</i> <i>Base .....steel plated metal</i>					
<b>Tuxedo • Tray</b>	<b>AXT3-1020</b>	10	20	2	\$889	
	<i>Top.....walnut or ash veneer</i>					

### Specify

Wood Finish  
Base Finish

<i>Product Number</i>	<i>Page</i>	<i>Product Number</i>	<i>Page</i>	<i>Product Number</i>	<i>Page</i>	<i>Product Number</i>	<i>Page</i>
AAG1A.....	11	AFRW .....	27	AMS4A.....	25	ASL4A.....	31
AAG1B.....	11	AFSA .....	27	AMS4B.....	25	ASL5A.....	31
AAG2A.....	11	AFSW .....	27	AMS5A.....	25	ASL6.....	31
AAG2B.....	11	ALH1A.....	23	AMS5B.....	25	AV3AL.....	12
AAG2C.....	11	ALH1B.....	24	AMS6.....	25	AV3AW.....	12
AAG3B.....	11	ALH2A.....	23	AMS7A.....	25	AV3WL.....	12
AAG3C.....	11	ALH2B.....	24	AMS7B.....	25	AV3WW.....	12
AAL1A.....	10	ALH3A.....	23	AMS8A.....	25	AWB1Z.....	16
AAL1B.....	10	ALNHTA.....	21	AMS8B.....	25	AWB2G.....	16
AAL2A.....	10	ALNHSN.....	21	AMW1A.....	26	AWB2M.....	16
AAL2B.....	10	ALNHSS.....	21	AMW2A.....	26	AWH2G.....	15
AAL2C.....	10	ALNHSSW.....	21	AMW2B.....	26	AWH2S.....	15
AAL3B.....	10	ALNLTA.....	22	AMW3.....	26	AWH2W.....	15
AAL3C.....	10	ALNLTW.....	22	ASB1A.....	28	AWR2.....	15
ACL1A.....	13	ALYDA.....	20	ASB1G.....	30	AXT3.....	32
ACL2A.....	13	ALYDW.....	20	ASB1T.....	29	AXW2.....	32
ADT1B.....	14	ALYSA.....	19	ASB1W.....	28	AXW3.....	32
AFCA.....	27	ALYSN.....	17	ASL1A.....	31		
AFCW.....	27	ALYSS.....	18	ASL2A.....	31		
AFRA.....	27	ALYSW.....	19	ASL3.....	31		



© 2018 Geiger International, Inc. All rights reserved.

® Geiger International is a registered trademark of Geiger International, Inc.

™ The Geiger logo, A Line, Brabo, Claw, Drum, Full Round, H Frame, I Beam, Layer, Loophole, Metal Series, Slimline, and Tuxedo are trademarks of Geiger International, Inc., and/or of its independent designers.