

Occasional Tables

Prices effective July 5, 2023

Published July 5, 2023

Specification Information

Terms and Conditions	2
Warranty	3
How to Specify	4
Base Finishes	5
Glass	5
Laminate	5
Leather	6
Stone	6
Wood Finishes	7-9

Occasional Tables

Brabo™	Vincent Van Duysen	12
Claw™	Ward Bennett	13
Full Round™	Ward Bennett	15
H Frame™	Ward Bennett	15
I Beam™	Ward Bennett	16
Layer™	BassamFellows	17-22
Loophole™	Jay Chapman	23-24
Metal Series™	Geiger Design Group	25-26
Reframe™	EOOS	27
Saiba™	Naoto Fukasawa	28-30
Tuxedo™	BassamFellows	32
Index		33

General Information

Terms and Conditions

Order Information

GEIGER

Application of Standard Terms

Only the standard terms of sale stated in this catalog apply to any transaction unless those terms are modified or supplemented by a written document signed by an officer of Geiger International, Inc. ("Geiger"). Any terms contained in Customer's purchase order, including standard printed provisions, that are additional to or contrary to these terms, are not effective.

Use of Furniture and Materials

Geiger assumes that textiles, leathers and products are intended for commercial use and are not being bought for use primarily for personal, family, or household purposes. When installed and used as intended, products remain chattel property, are not considered fixtures, and no interest in them should arise under applicable real estate law.

Furniture Prices

Prices are determined by using the published list prices in effect when Geiger receives Customer's completed purchase order. If Customer's requested ship date is more than three months after Geiger receives Customer's order, it may be repriced using the list prices in effect when products ship. If Customer designates special finishes or options, additional charges may apply. Services such as design, project management, packaging, storage, inside delivery, double handling, installation, or inventory management are not included in Geiger's list prices.

COM / COL Procedures

If an order includes Customer-supplied materials, Customer must ship those materials to Geiger at Customer's own expense. The materials must be tagged with Geiger's confirmation number, item number, Customer's name, and purchase order number. Geiger is not liable for inadequacies in Customer's materials. Geiger will notify Customer of any apparent defects in Customer's materials before manufacturing.

Taxes

Customer is responsible for any local sales taxes or other similar taxes imposed on transactions.

Delays

Geiger is not liable for failure to ship by the acknowledged shipping date or any other date. Geiger is not liable for a delay or failure in shipment or performance if the delay or failure is caused by acts of omission of Customer, its agents, employees, contractors, a governmental authority, or God; delays in transportation; or other similar causes that are not within Geiger's reasonable control. Geiger is excused from further performance of its obligations for the duration of a force majeure cause.

Changes and Cancellation

Geiger's acceptance of an order is final and binding and an order may not be changed or canceled without Geiger's written consent.

Orders placed on any of Geiger's expedited shipment programs and orders of custom-dyed or custom-woven materials may not be changed or canceled. To change or cancel other orders, contact Geiger Customer Care in writing for authorization and applicable charges.

Storage

If Customer cannot accept delivery when products are ready, it is the customer's responsibility to transfer products to storage and products are invoiced at that time. Customer is responsible for actual storage charges and any other expenses relating to the storage of products or materials. Customer bears all risk of loss for products or materials in storage.

Freight Terms

For casegoods and seating orders shipped within the 48 contiguous United States, surface freight charges are included. For textile and leather orders actual freight charges will be invoiced. Orders are shipped via ground carrier unless requested otherwise.

For orders shipped to Alaska or Hawaii, the freight terms stated above apply only to the port of embarkation. Shipments beyond that point are freight collect. Domestic deliveries are shipped FOB Geiger's plant to a destination designated by Customer by a method Geiger selects.

All textile shipments will be made FOB Geiger Textiles, Yaphank, NY 11980. All leather shipments will be made FOB Geiger Textiles, Hildebrand, NC 28637.

Packaging and Shipping

Geiger's casegoods products are shipped in component form. Shipments over \$50,000 net are blanket wrapped. Tops and panels are shrink wrapped with cardboard corner protection. Pedestals, storage units, overheads and vertical storage units are wrapped in blankets and shrink wrapped with cardboard corner protection. Blankets are to be returned to Geiger for reuse. If the customer request cartoning on orders over \$50,000 net, there will be a charge of five percent of the net order. Packing materials are recyclable.

Casegood shipments from Atlanta under \$50,000 net are cartoned. Cartoned shipments are packaged with cardboard channels and shrink wrap.

Geiger's seating is cartoned in boxes for all shipments. Blanket wrapping is available upon request.

If Customer requests special shipping or delivery methods, Customer is responsible for any extra costs that result.

Packaging and Shipping (continued)

Customer obtains title to products and materials and assumes the risk of loss for them upon shipment from Geiger's plant. Geiger reserves the right to make partial shipments, of truckload quantities, as products are manufactured.

Shipping Surcharge

A shipping surcharge will be added to all orders under \$100,000 list based on the ship-to address. The surcharge is a percentage of the total list price of the entire order, calculated on the base price only. Upcharges for veneer, edges, textiles, pulls, etc., are not counted in the calculation.

Zone 1	3.6% (GA, NC, SC)
Zone 2	4.2% (AL, FL, MS, TN, AR, LA)
Zone 3	4.0% (IL, IN, KY, MI, OH, WI, IA, KS, MN, MO, ND, NE, SD, DC, MD, VA)
Zone 4	5.4% (CT, MA, ME, NH, RI, VT, DE, NJ, NY, PA, WV)
Zone 5	6.0% (OK, TX, AZ, NM, NV, UT, CO)
Zone 6	6.6% (OR, WA, ID, MT WY, CA, Canada)

International Shipping

Orders for export are shipped Ex Works factory (Incoterms 2000). The charge for export packing is five percent of the net order value. There are no export packing charges on shipments to Canada.

Claims

All blanket wrapped shipments must be unwrapped and inspected at the dock, in the presence of the driver. Claims for "concealed damage" or "subject to inspection" will not be honored on blanket wrapped shipments. All cartoned shipments must be inspected for visual outside damage to the package.

Damages and piece count shortages must be noted on the bill of lading. Freight claims must be filed within 30 days (including cartoned shipments with concealed damage). Contact Customer Care for a warranty/freight claim form and send it by fax, mail or email to:

Geiger International
6095 Fulton Industrial Blvd., SW
Atlanta, GA 30336-2806
Attention: Warranty Department
Fax: 1.404.836.7519

Order Information

Herman Miller dealers must submit all purchase orders to Geiger via Omni. For assistance with this process, please contact Herman Miller Sales Technology Support at 800.833.3330.

All Geiger Gallery and non-Herman Miller dealers may submit their orders via email or fax at 404.836.7519. For assistance with this

Order Information (continued)

process, please contact Geiger Customer Care at 800.456.6452.

Midwest	custcaremw@geigerfurniture.com
New York	custcareny@geigerfurniture.com
Northeast	custcarene@geigerfurniture.com
South	custcaresouth@geigerfurniture.com
West	custcarewest@geigerfurniture.com
Int'l	custcareintl@geigerfurniture.com

Warranty

Geiger International, Inc. ("Geiger"), 6095 Fulton Industrial Blvd., SW, Atlanta, GA 30336-2806, USA, warrants the products sold by it to be free from defects in material and workmanship, regardless of the number of shifts during which the products are used, for the warranty periods specified below.

This warranty covers the sale of Geiger product in all countries. Not all of the product lines appearing on this list are marketed by Geiger in all countries, and appearance on this list does not imply an offer for sale of a product line in a particular place. Product line availability is defined in current price lists applicable to different regions.

Geiger Commercial Office Furniture Products 12 years

All products sold under the Geiger® brand name, except as limited or described below.

Textiles and Leathers 3 years

Includes, but is not limited to Edelman Leather, Geiger, Herman Miller, Maharam, and Place fabrics.

Nonstandard Products 1 to 5 years

Warranty length on nonstandard products not covered by the 12-year warranty is identified on individual product quotes.

All Other Products, Parts, and Services 2 years

Height adjustable bases (electrical parts)

5 years

Height adjustable bases (mechanical parts)
Task light electronic ballasts

3 years

All service parts

6 months

All other products, parts, and any services not listed above, sold or furnished by Geiger, except for consumable products such as light bulbs and other electronic products for which no warranty is given

Other Manufacturers' Products

None

Geiger will pass through to the original purchaser any warranty supplied by other manufacturers to the extent possible, including, but not limited

Warranty (continued)

to, open-line laminates.

Provisions that apply to all products and services:

During the applicable warranty period, Geiger, as its sole obligation, will repair or replace (at its option) any product, part, or component covered by this warranty and sold after the effective date of this warranty, which fails under normal use as a result of a defect in material or workmanship; Geiger will repair or replace the aforementioned product, part, or component with a comparable product, part, or component.

This warranty extends only to the original purchasers who acquire new product from Geiger, or its authorized resellers. Any product, part, or component must have been installed, used, and maintained according to Geiger's published instructions in order to be eligible for coverage under this warranty and must not have been subject to misuse or abuse. Any modification to the original product voids the warranty. Geiger does not warrant the performance of the product when used in combination with other than original Geiger product.

The warranty period starts from the date of purchase.

This document inclusively describes all of the warranties given and remedies available with respect to the company's products and services. Geiger disclaims any other warranty whether express or implied, statutory or otherwise, in relation to the products.

Geiger does not warrant:

- natural variations in wood grain or figure or the presence of character marks
- changes in surface finishes due to aging or exposure to light
- marks, scars, or wrinkles occurring naturally in leather
- veins, marks, voids, fissures, or cracks found naturally in stone

In addition, Geiger does not warrant:

- failure resulting from normal wear and tear
- the matching of colors, grains, or textures of natural materials
- the colorfastness or the matching of colors of textiles, including an exact match to cuttings or to swatch cards
- damage, marking, or staining of veneer surfaces due to contact with rubber or similar compounds; damage from sharp objects or imprinting from writing instruments, or prolonged exposure to direct sunlight

Geiger tests Customer's Own Material (COM) and other customer-supplied items for manufacturing quality only and does not provide any warranty with regard to these materials.

Geiger does not warrant products that are

Warranty (continued)

exposed to extreme environmental conditions or that have been subject to improper storage.

Geiger's products meet the requirements of national and specific local codes as stated in the price books and other written publications.

TO THE EXTENT ALLOWED BY LAW, ANY IMPLIED WARRANTIES, INCLUDING ANY WARRANTY OF MERCHANTABILITY OR FITNESS FOR A PARTICULAR PURPOSE, ARE DISCLAIMED AND TO THE EXTENT THEY ARE LEGALLY REQUIRED, ARE LIMITED IN DURATION TO THE DURATION OF THIS WRITTEN WARRANTY.

GEIGER SHALL NOT BE LIABLE FOR LOSS OF TIME, INCONVENIENCE, COMMERCIAL LOSS, OR INCIDENTAL OR CONSEQUENTIAL DAMAGES.

Applies in US only: Some states do not allow limitations on how long an implied warranty lasts or do not allow the exclusion or limitation of incidental or consequential damages, so the limitations or exclusions in the two preceding paragraphs may not apply. This warranty gives the purchaser specific legal rights; however, the purchaser may also have other rights that may vary from state to state.

Applies outside US: Except as stated above, Geiger will not be liable for any loss or damage (including costs) however caused, whether direct or consequential, incurred or suffered by the purchaser or any third party in respect of the products but nothing contained herein will or will be considered to exclude or restrict any liability on Geiger's part for death or personal injury resulting from negligence.

Limitations and Disclaimers

Geiger is not liable for loss of time, inconvenience, lost profits, commercial loss, or other special, consequential, or incidental damages for any transaction.

Geiger reserves the right to change its designs, its methods of construction, or its prices, charges, or policies at any time without notice to Customer.

Design Rights

The designs depicted in Geiger's catalogs and price lists are proprietary to Geiger and Geiger reserves the exclusive right to manufacture them. Any reproduction of these designs infringes Geiger's rights and that infringement will be prosecuted.

Occasional Tables

How To Specify

GEIGER

How to Specify

- For each product ordered, specify a product number string. The string should include the product number and all finish and detail codes listed at the bottom of the pricebook page.
- Specify the finishes and details in the same sequence shown on the pricebook page.
- Product Number String Example:
ALH1A36W 943 CHR CHR

The product number string above includes all required codes for a Loophole round table with walnut base with the following specifications:

Product Number ALH1A-36W
Wood Finish..... 943 Caramel Cherry
Glass Finish..... CGL Clear Glass

- Basic Price reflects the price of the table without optional features. Add upcharges as shown on the product page for anigre wood finishes, solid edge detail, etched glass, leg trim, inlay or marquetry. There is no upcharge for anigre base or leg finishes.

Base Finishes	Glass	Laminate
<i>For Claw, Metal Series (no upcharge)</i>	<i>For Claw, H Frame, Loophole, Metal Series (no upcharge)</i>	<i>For Saiba (no upcharge)</i>
926.....Black	CGL.....Clear Glass	91.....White
CHR.....Chrome		BK.....Black
EH.....Metallic Bronze		
MS.....Metallic Silver	<i>For A Line and Saiba table tops (no upcharge)</i>	Notes
SAC.....Satin Chrome	GBB.....Back-painted Black Glass	Laminate edge is black, even if 91 White is selected.
<i>For Brabo, Full Round and H Frame (no upcharge)</i>	GBP.....Back-painted White Glass	
CHR.....Chrome		
SAC.....Satin Chrome	<i>For H Frame table tops (add upcharge shown on the product page)</i>	
<i>For Layer (no upcharge)</i>	GE1.....Etched Glass	
926.....Black		
CHR.....Chrome		
SAC.....Satin Chrome		
<i>For Saiba (no upcharge)</i>	Notes	
926.....Black	GCE is clear glass with a 3" wide band of etched glass around the outside edge.	
CHR.....Chrome	CGL glass is 1/2" thick on H Frame and Metal Series tables and 3/4" thick on I Beam tables.	
<i>For Tuxedo (no upcharge)</i>	GE1 etched glass is 1/2" thick on H Frame tables and is not available on I Beam tables.	
926.....Black Gloss		
BK.....Black Matte		
AS.....Arctic Silver		
PBZ.....Powder Coat Bronze		
WHT.....White		
<i>For Tuxedo (add upcharge shown on the product page)</i>		
CHR.....Chrome		
SAC.....Satin Chrome		

Occasional Tables

Leather • Stone

GEIGER

Leather	Stone	
<i>For Brabo leather wrapped tops (add upcharge shown on the product page)</i>	<i>For tables with stone top except Layer</i>	<i>For Layer tables with stone top</i>
<p>Bristol Leather</p> <p>5-502 Tan 5-507 Black 5-511 Putty 5-512 Grebe 5-514 Iona 5-519 Hunter 5-520 White 5-521 Ivory 5-522 Parchment 5-524 Espresso 5-534 Pearl 5-537 Caribbean 5-546 Pumice 5-547 Smoke 5-548 Charcoal 5-549 Dark Shale 5-556 Downtown Grey 5-557 City Night 5-558 Neutral 5-559 Ash Gray 5-563 Champagne 5-564 Chestnut Brown 5-565 Dark Sienna 5-566 Earthen 5-567 Desert 5-568 British Green 5-569 Wrought Iron 5-579 Paris Blue 5-583 Atlantic 5-589 Umber 5-591 Bone 5-592 Camel 5-594 Taupe 5-597 Pure 5-598 Cream 5-599 Poppy 5-600 Midnight Blue 5-601 Deep Aubergine 5-602 Merlot 5-603 Sangria 5-604 Swiss Red 5-605 Nordic Yellow 5-606 Sky Gray</p>	<p>200.....Perlato Polished Marble 250.....Verde Polished Antique Marble 400.....Black Polished Granite 5U.....Georgia Grey Polished Marble 800.....Autumn Brown Polished Granite 960.....White Carrara Polished Marble DP.....Georgia White Polished Marble HR.....Wisconsin Black Honed Marble</p> <p style="background-color: #f0f0f0;">Notes</p> <p>Stone is 3/4" thick.</p>	<p>DPH.....Georgia White Honed Marble 5UH.....Georgia Grey Honed Marble HR.....Wisconsin Black Honed Marble</p> <p style="background-color: #f0f0f0;">Notes</p> <p>Marble is 1 3/16" thick with radiused edge and radiused corners.</p>

Wood Finishes

Wood Species Key

A	Ash	C	Cherry	O	Oak	SA	Sapele	W	Walnut
AN	Anigre	H	Hickory	P	Paldao	SY	Sycamore	WE	Wenge
B	Beech	M	Maple	R	Rosewood	T	Teak		

Code	Description	Upcharge*	A Line	Brabo	Drum	Full Round	H Frame	Layer	Loophole	Metal Series	Reframe	Saiba	Tuxedo
662	Toasted Walnut, matte		A	AW	W	W	W	W	AW	W	W	AW	W
663	Charred Walnut, matte		A	AW	W	W	W	W	AW	W	W	AW	W
664	Bronzed Walnut, matte		A	AW	W	W	W	W	AW	W	W	AW	W
665	Smoked Walnut, matte		A	AW	W	W	W	W	AW	W	W	AW	W
666	Coffee Walnut, matte		A	AW	W	W	W	W	AW	W	W	AW	W
667	Smoked Paldao, matte	+15%	A	AW	P	P	P		AW	P		AW	W
668	Figured Sycamore, matte	+40%			SY	SY	SY			SY			
669	Warm Paldao, matte	+15%	A	AW	P	P	P		AW	P		AW	W
677	Chocolate Ash, matte		A	A	A	A	A	A	A	A	A	A	A
678	Natural Oak, matte				O	O	O			O			
66A	RecoGrain Frosty Ash, matte		A	A					A			A	A
66G	RecoGrain Wenge, matte	-5%	A	AW					AW			AW	W
66W	RecoGrain Walnut, matte		A	A					A		A	A	A
68R	RecoGrain Rosewood, matte		A	AW	R	R	R		AW	R		AW	W
68W	RecoGrain Walnut, matte	-5%	A	A	W	W	W		A	W	A	A	A
69A	RecoGrain Frosty Ash, matte		A	A	A	A	A		A	A		A	A
69G	RecoGrain Wenge, matte	-5%	A	AW	WE	WE	WE		AW	WE		AW	W
69K	RecoGrain Oak, matte	-5%			O	O	O			O			
69R	RecoGrain Rosewood, matte		A	AW	R	R	R		AW	R		AW	W
69T	RecoGrain Teak, matte		A	A	T	T	T		A	T		A	A
69W	RecoGrain Walnut, matte	-5%	A	A	W	W	W		A	W	A	A	A
6A1	White Ash, matte		A	A	A	A	A	A	A	A	A	A	A
6ET	RecoGrain Natural Ash, Ash Solid, matte		A	A					A			A	A
6EU	RecoGrain Oak, Oak Solid, matte		A	A					A			A	A
6EV	RecoGrain Walnut, Walnut Solid, matte		A	AW					AW			AW	W
6K1	Rift Oak, matte		A	A	O	O	O		A	O		A	A
6K6	Burnt Oak, matte		A	A	O	O	O		A	O		A	A
911	Champagne Maple, low sheen				M	M	M			M			
940	Sundance Cherry on Maple, low sheen		A	A	M	M	M		A	M		A	A
941	Natural Beech, low sheen				B	B	B			B			
942	Sundance Cherry, low sheen				C	C	C			C			
943	Caramel Cherry, low sheen		A	A	C	C	C		A	C		A	A
946	Cocoa Cherry, low sheen		A	A	C	C	C		A	C		A	A
951	Natural Anigre, low sheen	+40%			AN	AN	AN			AN			
956	Cocoa Sapele, low sheen		A	A	SA	SA	SA		A	SA		A	A
962	Toasted Walnut, low sheen		A	AW	W	W	W		AW	W		AW	W

*Wood finish upcharge / downcharge applies only to Drum, Full Round, H Frame, and Metal Series tables. All other tables are produced in the wood species indicated and stained to match the color of the specified wood finish.

Occasional Tables

Wood Finishes

GEIGER

Wood Finishes (Continued)

Wood Species Key

A	Ash	C	Cherry	O	Oak	SA	Sapele	W	Walnut
AN	Anigre	H	Hickory	P	Paldao	SY	Sycamore	WE	Wenge
B	Beech	M	Maple	R	Rosewood	T	Teak		

Code	Description	Upcharge*	A Line	Brabo	Drum	Full Round	H Frame	Layer	Loophole	Metal Series	Reframe	Saiba	Tuxedo
963	Charred Walnut, low sheen		A	A W	W	W	W		A W	W		A W	W
964	Bronzed Walnut, low sheen		A	A W	W	W	W		A W	W		A W	W
965	Smoked Walnut, low sheen		A	A W	W	W	W		A W	W		A W	W
966	Coffee Walnut, low sheen		A	A W	W	W	W		A W	W		A W	W
967	Smoked Paldao, low sheen	+15%	A	A W	P	P	P		A W	P		A W	W
968	Figured Sycamore, low sheen	+40%			SY	SY	SY			SY			
969	Warm Paldao, low sheen	+15%	A	A W	P	P	P		A W	P		A W	W
972	Sundance Walnut, low sheen			W				W	W		W	W	W
977	Chocolate Ash, low sheen		A	A	A	A	A		A	A		A	A
978	Natural Oak, low sheen				O	O	O			O			
981	Champagne Hickory, low sheen				H	H	H			H			
991	Champagne Ash, low sheen		A	A	A	A	A	A	A	A	A	A	A
998	Ebony Ash, low sheen		A	A	A	A	A	A	A	A	A	A	A
96A	RecoGrain Frosty Ash, low sheen		A	A					A			A	A
96G	RecoGrain Wenge, low sheen	-5%	A	A W					A W			A W	W
96W	RecoGrain Walnut, low sheen		A	A					A		A	A	A
98R	RecoGrain Rosewood, low sheen		A	A W	R	R	R		A W	R		A W	W
98W	RecoGrain Walnut, low sheen	-5%	A	A	W	W	W		A	W	A	A	A
99A	RecoGrain Frosty Ash, low sheen				A	A	A			A			
99G	RecoGrain Wenge, low sheen	-5%	A	A W	WE	WE	WE		A W	WE		A W	W
99K	RecoGrain Oak, low sheen	-5%			O	O	O			O			
99R	RecoGrain Rosewood, low sheen		A	A W	R	R	R		A W	R		A W	W
99T	RecoGrain Teak, low sheen		A	A	T	T	T		A	T		A	A
99W	RecoGrain Walnut, low sheen	-5%	A	A	W	W	W		A	W	A	A	A
9A1	White Ash, low sheen		A	A	A	A	A		A	A		A	A
9K1	Rift Oak, low sheen		A	A	O	O	O		A	O		A	A
9K6	Burnt Oak, low sheen		A	A	O	O	O		A	O		A	A
ED	Aged Cherry, low sheen		A	A	C	C	C		A	C		A	A
EK	Medium Red Walnut, low sheen		A	A W	W	W	W	W	A W	W	W	A W	W
ET	RecoGrain Natural Ash, matte		A	A	A	A	A		A	A		A	A
EU	RecoGrain Oak, matte		A	A	O	O	O		A	O		A	A
EV	RecoGrain Walnut, matte		A	A W	W	W	W		A W	W		A W	W
G2U	Light Brown Walnut, low sheen		A	A W	W	W	W	W	A W	W	W	A W	W
G40	Dark Brown Walnut, low sheen		A	A W	W	W	W	W	A W	W	W	A W	W
GOU	Walnut, matte		A	A W		W	W	W	A W		W	A W	W
UX	Walnut On Cherry, low sheen		A	A	C	C	C		A	C		A	A

*Wood finish upcharge / downcharge applies only to Drum, Full Round, H Frame, and Metal Series tables. All other tables are produced in the wood species indicated and stained to match the color of the specified wood finish.

Wood Finishes (Continued)

Notes

Natural wood finishes are unstained to maintain the natural beauty and clarity of the wood. When the veneer and solid wood species are not the same the veneer and solid may differ in color and graining. When a stained wood finish is specified, the solid wood edges are stained to match the veneer top as closely as possible.

Special finish colors may be developed for orders over \$200,000 list upon request at no additional charge. A one time set-up fee of \$250 net will be charged on orders under \$200,000 list for each special finish. In order

to protect the quality and durability of Geiger's finish, the chemical composition of the staining materials, water-base sealers, and urethane top coats will not be altered for special finishes.

Exotic veneers such as pearwood, bird's eye maple and sycamore are available upon request, at additional cost.

For further information and procedures for special finishes or exotic veneers, contact your Geiger sales representative.

Custom Veneer Layup

Custom veneer layup is available on selected tables with one-piece tops. Contact your Geiger sales representative for availability, ordering information and upcharges.

Sunburst layup is not available in maple, bird's-eye maple or sycamore.

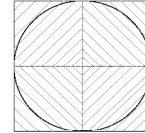

Diamond

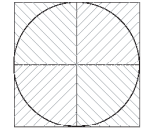

Reverse Diamond

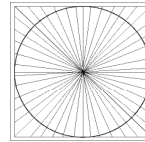



Sunburst

Occasional Tables

Brabo

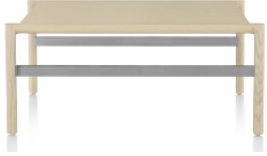
GEIGER

	Product Number	Depth	Width	Height	Basic Price	Leather Upcharges		
						Bristol	HMI	
Brabo <i>wood top</i> 	<i>ash frame</i>							
	AV3AW-332314	33	23	15 3/4	\$3,778			
	AV3AW-234814	23	48	15 3/4	\$4,155			
	<i>walnut frame</i>							
	AV3WW-332314	33	23	15 3/4	\$3,918			
	AV3WW-234814	23	48	15 3/4	\$4,350			
<i>Top.....ash or walnut veneer</i>								
<i>Framesolid ash or walnut and steel plated metal</i>								

Brabo <i>leather wrapped top</i> 	<i>ash frame</i>							
	AV3AL-332314	33	23	15 3/4	\$3,778	+193	+216	
	AV3AL-234814	23	48	15 3/4	\$4,155	+290	+324	
	<i>walnut frame</i>							
	AV3WL-332314	33	23	15 3/4	\$3,918	+193	+216	
	AV3WL-234814	23	48	15 3/4	\$4,350	+290	+324	
<i>Top.....wrapped in Bristol or MCL leather</i>								
<i>Framesolid ash or walnut and steel plated metal</i>								

Specify

Wood Finish

Leather, only available in Bristol or MCL leather (not required on tables with wood top)

Base Finish

	Product Number	Depth	Width	Height	Basic Price
Claw • Tri-Leg Round	ACL1A-20	20	20	16	\$3,676
	ACL1A-24	24	24	16	\$4,047
	ACL1A-36	36	36	16	\$4,476



Top.....3/4" thick clear glass
 Basemetal

Claw • Four-Leg Square	ACL2A-3636	36	36	16	\$4,506
	ACL2A-4040	40	40	16	\$4,858



Top.....3/4" thick clear glass
 Basemetal

Specify

Base Finish

	Product Number	Depth	Width	Height	Basic Price
Crosshatch Outdoor Coffee Rectangle	ASOCRT	30	56	12.5	\$1,895



Top.....Solid wood slate teak

BaseSolid wood frame teak

Crosshatch Outdoor Coffee Square	ASOCST	30	30	12.5	\$1,595
---	---------------	----	----	------	---------



TopSolid wood slate teak

BaseSolid wood frame teak

Standard Discount on Crosshatch Outdoor not to Exceed 32.5%

Warranty for Crosshatch Outdoor Furniture is 3 years

Specify

	Product Number	Depth	Width	Height	Basic Price
--	----------------	-------	-------	--------	-------------

Crosshatch Outdoor Side Square	ASOSST	20	20	15	\$795
---------------------------------------	---------------	----	----	----	-------



TopSolid wood slate teak
 BaseSolid wood frame teak

Crosshatch Outdoor Side Trilobe	ASOSTT	17 1/8"	17 7/16"	18 3/4"	\$795
--	---------------	---------	----------	---------	-------



TopSolid wood teak
 BaseSolid wood frame teak

Contact your local Geiger Account Manager for discounting information

Warranty for Crosshatch Outdoor Furniture is 3 Years

Specify

	Product Number	Basic Price
	SOCV2 Trilobe Side Table	\$145
	SOCV5 Square Side Table	\$145
	SOCV6 Square Coffee Table	\$345
	SOCV7 Rectangle Coffee Table	\$345

Crosshatch furniture cover. Made to ward off the elements year-round, these covers are constructed of tough Weathermax, a 100% solution-dyed all-weather polyester designed especially for outdoor use. They're breathable; resistant to water, mildew, abrasion and sun exposure; and easy to clean.

This sofa has a fire-retardent free foam and down topper with a solid wood base.

Specify

	Product Number	Depth	Width	Height	Basic Price	Etched Glass
Full Round Table <i>wood top</i> 	AWR2-2020	20	20	17	\$2,271	
	AWR2-2424	24	24	17	\$2,573	
	AWR2-3020	30	30	17	\$2,810	
	AWR2-3030	30	20	17	\$3,083	
	AWR2-4020	40	20	17	\$3,006	

H Frame Table 	<i>with wood top</i> AWH2W-1820	18	20	17	\$2,799	
	<i>with glass top</i> AWH2G-1820	18	20	17	\$2,122	+136
	<i>with stone top</i> AWH2S-1820	18	20	17	\$3,706	

H Frame Table 	<i>with wood top</i> AWH2W-3636	36	36	17	\$5,063	
	<i>with glass top</i> AWH2G-3636	36	36	17	\$4,524	+310
	<i>with stone top</i> AWH2S-3636	36	36	17	\$9,667	

Note: clearance between bottom shelf and underside of top is 13"

Specify

Wood Finish (required on wood tables only)
 Glass (required on glass tables only)
 Stone (required on stone tables only)
 Base Finish

Occasional Tables

I Beam

GEIGER

	Product Number	Depth	Width	Height	Basic Price
I Beam Table	AWB1Z-161615	16	16	14 1/2	\$2,341
	AWB1Z-181815	18	18	14 1/2	\$2,511



Baseblack powder-coated cast aluminum

I Beam Table • Glass Top	AWB2G-363615	36	36	15 1/4	\$3,596
	AWB2G-404015	40	40	15 1/4	\$3,866



Top..... CGL Glass, 3/4" thick
Baseblack powder-coated cast aluminum

I Beam Table • Stone Top	AWB2M-363616	36	36	16	\$7,255
	AWB2M-404016	40	40	16	\$7,932



Top..... 3/4" thick with 3/4" thick painted recessed sub top painted to match stone,
sub top is recessed 6" all around
Baseblack powder-coated cast aluminum

Specify

Glass (required on glass tables only), available only in CGL clear glass, GE1 etched glass not available on I Beam tables
Stone (required on stone tables only)

	Product Number	Depth	Width	Height	Basic Price
Layer <i>no shelf</i>	ALYSN-28Z14Z16Z	14	28	16	\$1,622
	ALYSN-28Z22Z16Z	22	28	16	\$1,895
	ALYSN-46Z24Z16Z	24	46	16	\$2,571
	ALYSN-66Z28Z16Z	28	66	16	\$2,978



Glass Top 1/2" thick low iron tempered glass with radiused top edge and radiused corners
Base stainless steel

Specify

Base Finish

Occasional Tables

Layer • Stone Shelf

GEIGER

	Product Number	Depth	Width	Height	Basic Price
Layer <i>stone shelf</i>	ALYSS-28Z14Z16Z	14	28	16	\$3,249
	ALYSS-28Z22Z16Z	22	28	16	\$3,521
	ALYSS-46Z24Z16Z	24	46	16	\$5,147
	ALYSS-66Z28Z16Z	28	66	16	\$5,689



Glass Top 1/2" thick low iron tempered glass with radiused top edge and radiused corners
Base stainless steel
Stone Shelf 1 3/16" thick with radiused edge and radiused corners.

Specify

Stone Finish
Base Finish

	Product Number	Depth	Width	Height	Basic Price
Layer <i>wood shelf</i> 	<i>ash shelf</i>				
	ALYSA-28Z14Z16Z	14	28	16	\$2,301
	ALYSA-28Z22Z16Z	22	28	16	\$2,843
	ALYSA-46Z24Z16Z	24	46	16	\$3,249
	ALYSA-66Z28Z16Z	28	66	16	\$3,791
	<i>walnut shelf</i>				
	ALYSW-28Z14Z16Z	14	28	16	\$2,301
	ALYSW-28Z22Z16Z	22	28	16	\$2,843
	ALYSW-46Z24Z16Z	24	46	16	\$3,249
	ALYSW-66Z28Z16Z	28	66	16	\$3,791

Glass Top 1/2" thick low iron tempered glass with radiused top edge and radiused corners
Base stainless steel
Wood Shelf 1" thick with plank veneer layup, solid wood edge, and finished to match color and sheen of specified wood finish.

Specify

Wood Finish
Base Finish

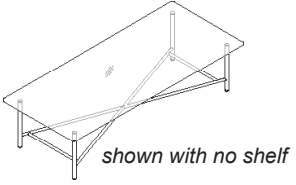
	Product Number	Depth	Width	Height	Basic Price
Layer <i>nesting table, high</i>  <i>shown with no shelf</i>	<i>no shelf</i> ALNHSN-66Z28Z16Z	28	66	16	\$2,978
	<i>ash shelf</i> ALNHSA-66Z28Z16Z	28	66	16	\$4,333
	<i>walnut shelf</i> ALNHSW-66Z28Z16Z	28	66	16	\$4,333
	<i>stone shelf</i> ALNHSS-66Z28Z16Z	28	66	16	\$6,910

Glass Top 1/2" thick low iron tempered glass with radiused top edge and radiused corners
Base stainless steel
Wood Shelf 1" thick with plank veneer layup, solid wood edge, and finished to match color and sheen of specified wood finish.

Specify

Wood Finish (for tables with wood shelf)
Stone Finish (for tables with stone shelf)
Base Finish

Occasional Tables

Layer • Nesting Table • Low

GEIGER

	Product Number	Depth	Width	Height	Basic Price
--	----------------	-------	-------	--------	-------------

Layer
nesting table, low

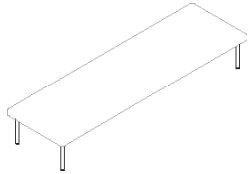

<i>ash shelf</i> ALNLTA-66Z20Z10Z	20	66	10	\$2,435
<i>walnut shelf</i> ALNLTW-66Z20Z10Z	20	66	10	\$2,435

Base stainless steel

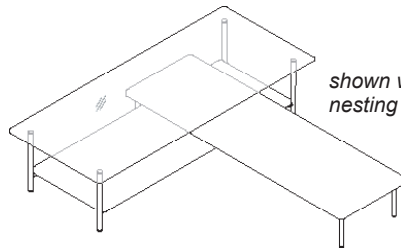

Wood top 1 1/4" thick with plank veneer layup, solid wood edge, and finished to match color and sheen of specified wood finish.



shown with ALNHSA-66Z28Z16Z
nesting table, high

Specify

Stone Finish
Base Finish

	Product Number	Depth	Width	Height	Basic Price
Loophole • Round 	<i>walnut frame</i>				
	ALH1A-36W	36	36	14	\$3,009
	ALH1A-42W	42	42	14	\$3,347
	<i>ash frame</i>				
	ALH1A-36A	36	36	14	\$3,009
	ALH1A-42A	42	42	14	\$3,347
	<i>Top..... 1/2' low iron clear glass with flat polished edge</i>				
	<i>Basesolid ash or solid walnut</i>				
Loophole • Square 	<i>walnut frame</i>				
	ALH2A-3636W	36	36	14	\$3,170
	ALH2A-4242W	42	42	14	\$3,558
	<i>ash frame</i>				
	ALH2A-3636A	36	36	14	\$3,170
	ALH2A-4242A	42	42	14	\$3,558
	<i>Top..... 1/2' low iron clear glass with flat polished edge</i>				
	<i>Basesolid ash or solid walnut</i>				
Loophole • Rectangular 	<i>walnut frame</i>				
	ALH3A-2436W	24	36	14	\$2,739
	ALH3A-3042W	30	42	14	\$3,254
	<i>ash frame</i>				
	ALH3A-2436A	24	36	14	\$2,739
	ALH3A-3042A	30	42	14	\$3,254
	<i>Top..... 1/2' low iron clear glass with flat polished edge</i>				
	<i>Basesolid ash or solid walnut</i>				



Note: table base can be installed in the field inverted with the wide end at the bottom



Specify

Wood Finish (available only in ash and walnut)
 Glass (available only in CGL clear glass)

Occasional Tables

Loophole • End Table

GEIGER

	Product Number	Depth	Width	Height	Basic Price
Loophole • Round 	walnut frame ALH1B-21W	21	21	20	\$2,358
	ash frame ALH1B-21A	21	21	20	\$2,358
<i>Top..... 1/2' low iron clear glass with flat polished edge</i> <i>Base solid ash or solid walnut</i>					
Loophole • Square 	walnut frame ALH2B-2121W	21	21	20	\$2,443
	ash frame ALH2B-2121A	21	21	20	\$2,443
<i>Top..... 1/2' low iron clear glass with flat polished edge</i> <i>Base solid ash or solid walnut</i>					



note: table base can be installed in the field inverted with the wide end at the bottom

Specify

Wood Finish (available only in ash and walnut)
 Glass (available only in CGL clear glass)

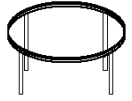
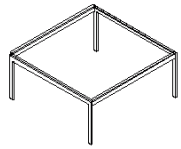
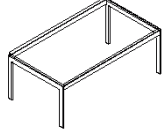
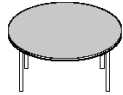
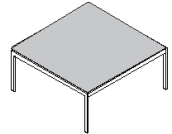
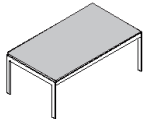
	Product Number	Depth	Width	Height	Basic Price
Metal Series • Round <i>with glass top</i> 	AMS4A-24	24	24	16	\$3,211
	AMS4A-30	30	30	16	\$3,787
	AMS4A-36	36	36	16	\$4,655
	AMS4A-42	42	42	16	\$5,576
	AMS4B-24	24	24	20	\$3,295
	<i>Top..... 1/2" thick clear glass</i> <i>Basemetal</i>				
Metal Series • Square <i>with glass top</i> 	AMS5A-2424	24	24	16	\$3,211
	AMS5A-3636	36	36	16	\$4,655
	AMS5B-2424	24	24	20	\$3,321
	<i>Top..... 1/2" thick clear glass</i> <i>Basemetal</i>				
Metal Series • Rectangular <i>with glass top</i> 	AMS6-2442	24	42	16	\$3,627
	AMS6-2448	24	48	16	\$3,863
	<i>Top..... 1/2" thick clear glass</i> <i>Basemetal</i>				
Metal Series • Round <i>with stone top</i> 	AMS7A-24	24	24	16	\$4,456
	AMS7A-30	30	30	16	\$5,818
	AMS7A-36	36	36	16	\$7,884
	AMS7A-42	42	42	16	\$9,980
	AMS7B-24	24	24	20	\$4,506
	<i>Top..... 3/4" thick stone</i> <i>Basemetal</i>				
Metal Series • Square <i>with stone top</i> 	AMS8A-2424	24	24	16	\$4,456
	AMS8A-3636	36	36	16	\$7,884
	AMS8B-2424	24	24	20	\$4,545
	<i>Top..... 3/4" thick stone</i> <i>Basemetal</i>				
Metal Series • Rectangular <i>with stone top</i> 	AMS9-2442	24	42	16	\$5,909
	AMS9-2448	24	48	16	\$6,329
	<i>Top..... 3/4" thick stone</i> <i>Basemetal</i>				

Specify

Stone (required on stone tables only)
 Glass (required on glass tables only), available only in CGL clear glass
 Base Finish

Occasional Tables

Metal Series • Wood Top

GEIGER

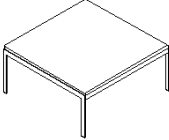
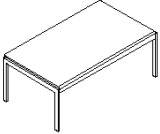
	Product Number	Depth	Width	Height	Basic Price
Metal Series • Round <i>with wood top</i> 	AMW1A-24	24	24	16	\$2,916
	AMW1A-30	30	30	16	\$3,295
	AMW1A-36	36	36	16	\$3,947
	AMW1A-42	42	42	16	\$4,569
	AMW1B-24	24	24	20	\$2,967
	<i>Top.....3/4" thick wood</i> <i>Basemetal</i>				
Metal Series • Square <i>with wood top</i> 	AMW2A-2424	24	24	16	\$2,916
	AMW2A-3636	36	36	16	\$3,947
	AMW2B-2424	24	24	20	\$3,001
		<i>Top.....3/4" thick wood</i> <i>Basemetal</i>			
Metal Series • Rectangular <i>with wood top</i> 	AMW3-2442	24	42	16	\$3,001
	AMW3-2448	24	48	16	\$3,161
		<i>Top.....3/4" thick wood</i> <i>Basemetal</i>			

Specify

Wood Finish
Base Finish

	Product Number	Depth	Width	Height	Basic Price
Reframe • Round 	<i>ash</i> AFC A	36 1/4"	36 1/4"	13 7/8"	\$1,458
	<i>walnut</i> AFCW	36 1/4"	36 1/4"	13 7/8"	\$1,857
<i>Top..... 1 1/2" thick, veneered top with solid edge</i>					
<i>Legs..... solid wood</i>					
Reframe • Square 	<i>ash</i> AFSA	26 1/2"	26 1/2"	13 7/8"	\$1,325
	<i>walnut</i> AFSW	26 1/2"	26 1/2"	13 7/8"	\$1,724
<i>Top..... 1 1/2" thick, veneered top with solid edge</i>					
<i>Legs..... solid wood</i>					
Reframe • Rectangular 	<i>ash</i> AFRA	18 7/8"	26 1/2"	13 7/8"	\$1,124
	<i>walnut</i> AFRW	18 7/8"	26 1/2"	13 7/8"	\$1,390
<i>Top..... 1 1/2" thick, veneered top with solid edge</i>					
<i>Legs..... solid wood</i>					

Specify

Wood Finish

Occasional Tables

Saiba • Wood Top

GEIGER

	Product Number	Depth	Width	Height	Basic Price
Saiba 	<i>ash</i>				
	ASB1A-1630	30	30	16	\$2,216
	ASB1A-1636	36	36	16	\$2,424
	ASB1A-1640	40	40	16	\$2,631
	ASB1A-2630	30	30	26 1/2	\$2,287
	ASB1A-2636	36	36	26 1/2	\$2,492
	ASB1A-2640	40	40	26 1/2	\$2,699
	ASB1A-2930	30	30	29	\$2,354
	ASB1A-2936	36	36	29	\$2,561
	ASB1A-2940	40	40	29	\$2,768
	<i>walnut</i>				
	ASB1W-1630	30	30	16	\$2,354
	ASB1W-1636	36	36	16	\$2,561
	ASB1W-1640	40	40	16	\$2,768
	ASB1W-2630	30	30	26 1/2	\$2,424
	ASB1W-2636	36	36	26 1/2	\$2,631
	ASB1W-2640	40	40	26 1/2	\$2,838
	ASB1W-2930	30		29	\$2,492
ASB1W-2936	36		29	\$2,699	
ASB1W-2940	40		29	\$2,907	

Top.....ash or walnut veneer
Baseblack or chrome finished aluminum

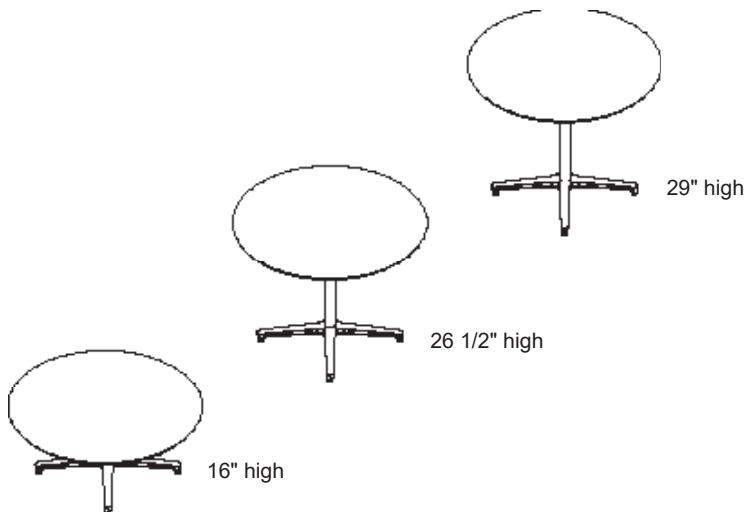

Specify

Wood Finish
Base Finish

	Product Number	Depth	Width	Height	Basic Price
Saiba 	<i>laminata</i>				
	ASB1T-1630	30	30	16	\$1,800
	ASB1T-1636	36	36	16	\$2,216
	ASB1T-1640	40	40	16	\$2,768
	ASB1T-2630	30	30	26 1/2	\$1,869
	ASB1T-2636	36	36	26 1/2	\$2,287
	ASB1T-2640	40	40	26 1/2	\$2,838
	ASB1T-2930	30	30	29	\$1,938
	ASB1T-2936	36	36	29	\$2,354
	ASB1T-2940	40	40	29	\$2,907

Top.....laminata with black edge
 Basealuminum

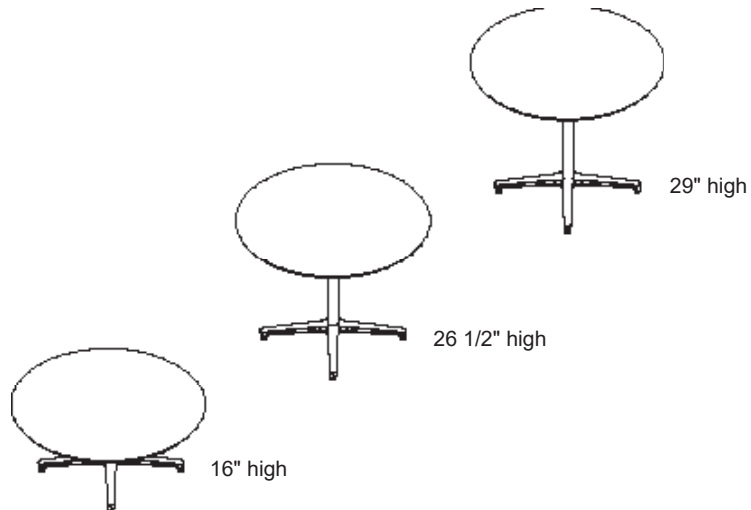

Specify

Base Finish
 Laminate

Occasional Tables

Saiba • Glass Top

GEIGER

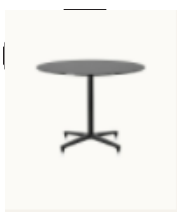
	Product Number	Depth	Width	Height	Basic Price
Saiba 	<i>back-painted glass</i>				
	ASB1G-1630	30	30	16	\$2,768
	ASB1G-1636	36	36	16	\$3,458
	ASB1G-1640	40	40	16	\$4,152
	ASB1G-2630	30	30	26 1/2	\$2,838
	ASB1G-2636	36	36	26 1/2	\$3,529
	ASB1G-2640	40	40	26 1/2	\$4,221
	ASB1G-2930	30	30	29	\$2,907
	ASB1G-2936	36	36	29	\$3,599
	ASB1G-2940	40	40	29	\$4,290

Top.....back-painted glass
 Baseblack or chrome finished aluminum

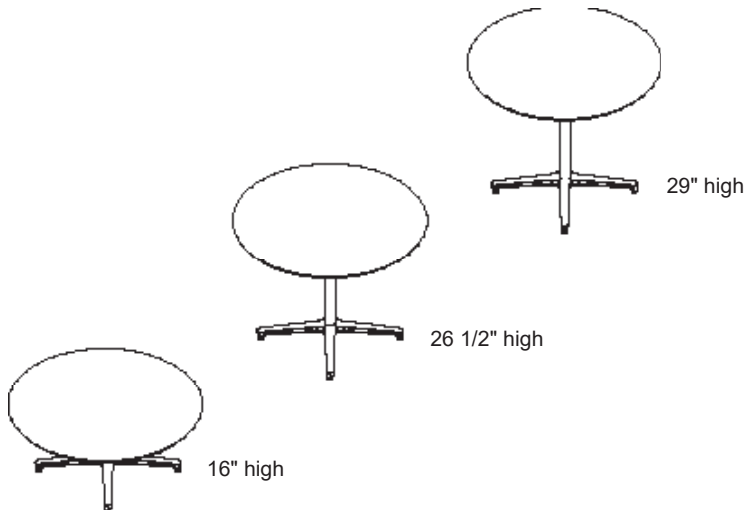

Specify

Glass
 Base Finish

Occasional Tables

Tuxedo

GEIGER

	Product Number	Depth	Width	Height	Basic Price	Base
Tuxedo • Square	AXW2-2828	28	28	14	\$2,238	+307



*Top.....walnut or ash veneer
Basesteel plated metal*

Tuxedo • Rectangular	AXW3-2028	20	28	14	\$1,981	+307
-----------------------------	------------------	----	----	----	---------	------



*Top.....walnut or ash veneer
Basesteel plated metal*

Tuxedo • Rectangular	AXW3-2856	28	56	14	\$3,730	+671
-----------------------------	------------------	----	----	----	---------	------

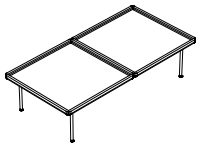

*Top.....walnut or ash veneer
Basesteel plated metal*

Tuxedo • Tray	AXT3-1020	10	20	2	\$1,069	
----------------------	------------------	----	----	---	---------	--



Top.....walnut or ash veneer

Specify

Wood Finish
Base Finish

<i>Product Number</i>	<i>Page</i>	<i>Product Number</i>	<i>Page</i>	<i>Product Number</i>	<i>Page</i>	<i>Product Number</i>	<i>Page</i>
AAG1A.....	11	AFRW	27	AMS4A.....	25	ASL4A.....	31
AAG1B.....	11	AFSA	27	AMS4B.....	25	ASL5A.....	31
AAG2A.....	11	AFSW	27	AMS5A.....	25	ASL6.....	31
AAG2B.....	11	ALH1A.....	23	AMS5B.....	25	AV3AL.....	12
AAG2C.....	11	ALH1B.....	24	AMS6.....	25	AV3AW.....	12
AAG3B.....	11	ALH2A.....	23	AMS7A.....	25	AV3WL.....	12
AAG3C.....	11	ALH2B.....	24	AMS7B.....	25	AV3WW.....	12
AAL1A.....	10	ALH3A.....	23	AMS8A.....	25	AWB1Z.....	16
AAL1B.....	10	ALNHTA.....	21	AMS8B.....	25	AWB2G.....	16
AAL2A.....	10	ALNHSN.....	21	AMW1A.....	26	AWB2M.....	16
AAL2B.....	10	ALNHSS.....	21	AMW2A.....	26	AWH2G.....	15
AAL2C.....	10	ALNHSSW.....	21	AMW2B.....	26	AWH2S.....	15
AAL3B.....	10	ALNLTA.....	22	AMW3.....	26	AWH2W.....	15
AAL3C.....	10	ALNLTW.....	22	ASB1A.....	28	AWR2.....	15
ACL1A.....	13	ALYDA.....	20	ASB1G.....	30	AXT3.....	32
ACL2A.....	13	ALYDW.....	20	ASB1T.....	29	AXW2.....	32
ADT1B.....	14	ALYSA.....	19	ASB1W.....	28	AXW3.....	32
AFCA.....	27	ALYSN.....	17	ASL1A.....	31		
AFCW.....	27	ALYSS.....	18	ASL2A.....	31		
AFRA.....	27	ALYSW.....	19	ASL3.....	31		

© 2023 Geiger International, Inc. All rights reserved.

® Geiger International is a registered trademark of Geiger International, Inc.

™ The Geiger logo, A Line, Brabo, Claw, Drum, Full Round, H Frame, I Beam, Layer, Loophole, Metal Series, Slimline, and Tuxedo are trademarks of Geiger International, Inc., and/or of its independent designers.